

RULES FOR COMPETITIONS

BOOK 1. TECHNICAL RULES

Article

PART I. GENERAL RULES AND RULES COMMON TO THE THREE WEAPONS

CHAPTER 1. APPLICATION OF THE RULES	
Obligatory use of the rules	t.1
CHAPTER 2. GLOSSARY	
Competitions	
Assaults and bouts	t.2
Match	t.3
Competition	t.4
Championship	t.5
Explanation of some technical terms	
Fencing time	t.6
Offensive and defensive actions	t.7
Offensive actions	t.8
Defensive actions	t.9
The point in line position	t.10
CHAPTER 3. THE FIELD OF PLAY	t.11–14
CHAPTER 4. THE FENCERS' EQUIPMENT	
Responsibility of fencers	t.15
CHAPTER 5. FENCING	
Method of holding the weapon	t.16
Coming on guard	t.17
Beginning, stopping and restarting the bout	t.18
Fencing at close quarters	t.19
Corps à corps	t.20
Displacing the target and passing the opponent	t.21
Substitution and use of the non-sword hand and arm	t.22–23
Ground gained or lost	t.24–25
Crossing the limits of the piste	
Stopping the bout	t.26
Rear limits	t.27
Lateral boundaries	t.28
Leaving the piste accidentally	t.29

Duration of the bout	t.30–32
Accidents, withdrawal of a competitor	t.33
CHAPTER 6. REFEREEING AND JUDGING OF HITS	t.34
The Referee	t.35
Judges	t.36
Attribution of referees	
Olympic Games and World Championships	
Individual competitions	t.37
Team competitions	t.38
World Cup competitions	t.39
Method of judging hits	
Materiality of the hit	t.40–41
Validity or priority of the hit	t.42
Regulation equipment and checking of equipment by the Referee	t.43–44
Non-regulation equipment	t.45

PART 2. FOIL

THE CONVENTIONS OF FENCING

METHOD OF MAKING A HIT	t.46
TARGET	
Limitation of the target	t.47
Hits off the target	t.48
Extension of the valid target	t.49
JUDGING OF HITS AT FOIL	t.50
Materiality of the hit	t.51–52
Annulment of a hit	t.53–54
Validity or priority of the hit	
Preface	t.55
Respect of the fencing phrase	t.56–59
Judging of hits	t.60

PART 3. EPEE

THE CONVENTIONS OF FENCING

METHOD OF MAKING A HIT	t.61
THE TARGET	t.62
CORPS A CORPS AND FLECHE ATTACKS	t.63
JUDGING OF HITS AT EPEE	t.64
Basic principle	t.65
The annulment of hits	t.66–69

PART 4. SABRE
THE CONVENTIONS OF FENCING

METHOD OF MAKING A HIT	t.70
THE TARGET	t.71–72
JUDGING OF HITS AT SABRE	
Materiality and annulment of hits	t.73
Validity or priority of the hit	
Preface	t.74
Respect of the fencing phrase	t.75–79
Judging of hits	t.80

PART 5. DISCIPLINARY RULES
FOR COMPETITIONS

CHAPTER 1. APPLICATION

Persons subject to these rules	t.81
Maintenance of order and discipline	t.82–83
The competitors	
Pledge of honour	t.84
Refusing to fence an opponent	t.85
Presence on time	t.86
Fencing etiquette	t.87
Personal effort	t.88
The team manager	t.89
The team captain	t.90
The referees and judges	t.91
The instructors, trainers and technicians	t.92
The spectators	t.93

CHAPTER 2. THE DISCIPLINARY AUTHORITIES AND
THEIR COMPETENCE

Jurisdiction	t.94
Principle of jurisdiction	t.95
The Referee	t.96
The Directoire Technique	t.97
The Executive Committee of the IOC at the Olympic Games	t.98
FIE — Central Office, Disciplinary Commission, Executive Committee	t.99

CHAPTER 3. PENALTIES

Classification of penalties	t.100–101
Penalties related to fencing	t.102–105
Disciplinary penalties	t.106–112
Announcement of penalties	t.113

CHAPTER 4. THE PENALTIES AND THE COMPETENT	
JURIDICAL AUTHORITIES	
The types (groups) of penalty	t.114
Competence	t.115
The First Group of offences	t.116
The Second Group of offences	t.117
The Third Group of offences	t.118
The Fourth Group of offences	t.119
Schedule of offences and penalties	t.120
CHAPTER 5. PROCEDURE	
Basic principle	t.121
Protests and appeals	t.122–123
Investigation — Right of defence	t.124
Method of decision	t.125
Repetition of offence	t.126
CHAPTER 6. ANTI-DOPING CONTROLS	
Anti-doping controls	t.127

BOOK 1. TECHNICAL RULES

PART I. GENERAL RULES AND RULES COMMON TO THE THREE WEAPONS

CHAPTER 1. APPLICATION OF THE RULES

Obligatory use of the Rules

- t.1. These Rules are obligatory **without modification** for the ‘Official Competitions of the FIE’, viz.:
- The World Championships, in all categories
 - The fencing events at the Olympic Games
 - All World Cup competitions.
 - The Zonal Championships.

CHAPTER 2. GLOSSARY

COMPETITIONS

Assaults and bouts

- t.2. A **friendly combat** between two fencers is called an *assault*. When the score of such an assault is kept to determine a result it is called a *bout*.

Match

- t.3. The aggregate of the bouts fought between the fencers of two different teams is called a *match*.

Competition

- t.4. 1. A *competition* is the **aggregate** of the bouts (individual competitions) or of the matches (team competitions) required to determine the winner of the event.
2. Competitions are **distinguished** by weapons, by the competitors’ sex, by their age and by the fact that they are for individuals or for teams.

Championship

- t.5. A *championship* is the name given to a competition **held to determine the best fencer or the best team** at each weapon for a federation, for a specific region or for the world and **for a specific period of time**.

EXPLANATION OF SOME TECHNICAL TERMS COMMONLY USED IN THE JUDGING OF FENCING ¹

Fencing time

- t.6. *Fencing time* is the time required to perform one simple fencing action.

1. It is stressed that this section in no way replaces a treatise on fencing and is only included in order to help the reader to understand the Rules.

Offensive and defensive actions

- t.7. 1. The *offensive actions* are the attack, the riposte and the counter-riposte.
- The *attack* is the initial offensive action made by extending the arm and continuously threatening the opponent's target, preceding the launching of the lunge or flèche (cf. t.56ss, t.75ss).
 - The *riposte* is the offensive action made by the fencer who has parried the attack.
 - The *counter-riposte* is the offensive action made by the fencer who has parried the riposte.
2. The *defensive actions* are the parries.
- The *parry* is the defensive action made with the weapon to prevent an offensive action arriving.

Explanation

t.8. *Offensive actions*

1. The attack

The action is *simple* when it is executed in one movement and is

- either *direct* (in the same line)
- or *indirect* (in another line).

The action is *compound* when it is executed in several movements.

2. The riposte

The riposte may be *immediate* or *delayed*, depending on what action takes place and the speed at which it is carried out.

Ripostes are:

a) Simple, direct

- *Direct riposte*: a riposte which hits the opponent without leaving the line in which the parry was made.
- *Riposte along the blade*: a riposte which hits the opponent by grazing along the blade after the parry.

b) Simple, indirect

- *Riposte by disengagement*: a riposte which hits the opponent in the opposite line to that in which the parry was formed (by passing under the opponent's blade if the parry was formed in the high line, and over the blade if the parry was formed in the low line).
- *Riposte with a coupé*: a riposte which hits the opponent in the opposite line to that in which the parry was formed (the blade always passing over the opponent's point).

c) Compound

- *Riposte with a doublé*: a riposte which hits the opponent in the opposite line to that in which the parry was formed, but after having described a complete circle round the opponent's blade.
- *Riposte with a one-two*: a riposte which hits the opponent in the same line as that in which the parry was formed but after the blade has first been into the opposite line, by passing under the opponent's blade.

3. Counter-attacks

Counter-attacks are offensive or offensive-defensive actions made during the offensive action of the opponent.

a) The *stop hit*

A counter-attack made into an attack.

b) The *stop hit made with opposition*

A counter-attack made while closing the line in which the opponent's attack will be completed (cf. t.56ss, t.64ss and t.76ss).

c) The *stop hit made within a period of fencing time*, i.e. 'in time' (cf. t.59, t.79).

4. Other offensive actions

a) The *remise*

A **simple and immediate offensive** action which follows the original attack, **without withdrawing the arm**, after the opponent has parried or retreated, when the latter has either quitted contact with the blade without riposting or has made a riposte which is delayed, indirect or compound.

b) The *redoublement*

A **new action**, either simple or compound, made against an opponent who has parried without riposting or who has merely avoided the first action by retreating or displacing the target.

c) The *reprise of the attack*

A **new attack** executed immediately **after a return to the on-guard position**.

d) *Counter-time*

Any action made by the attacker against a stop hit made by his opponent.

Defensive actions

t.9. Parries are *simple, direct*, when they are made in the same line as the attack.

They are *circular* (counter-parries) when they are made in the opposite line to that of the attack.

The point in line position

- t.10.** The **point in line** position is a specific position in which the fencer's sword arm is kept straight and the point of his weapon continually threatens his opponent's valid target (cf. t.56.3.a/b/c, t.60.4.e, t.60.5.a, t.76, t.80.3.e, t.80.4.a/b).

CHAPTER 3. THE FIELD OF PLAY

- t.11.** The **field of play** should have an even surface. It should give neither advantage nor disadvantage to either of the two fencers concerned, especially as regards light.
- t.12.** 1. That portion of the field of play which is used for fencing is called the *piste*.
2. Competitions **at the three weapons** are fenced on the same pistes.
- t.13.** 1. The piste is from 1.50 metres to 2 metres **wide**.
2. The piste is 14 metres **long**, so that each competitor being placed at 2 metres from the centre line has at his disposal for retreating a total distance of 5 metres without it being necessary for him to cross the rear limit of the piste with both feet.
- t.14.** **Five lines** should be drawn very clearly on the piste at right angles to its length, as follows:
- one centre line** which must be drawn as a broken line across the whole width of the piste;
 - two on-guard lines** at 2 metres on each side of the centre line. These must be drawn across the whole width of the piste;
 - two lines at the rear limits** of the piste, which must be drawn across the whole width of the piste, at a distance of 7 metres from the centre line.
 - In addition, **the last 2 metres** of the piste before these rear limit lines must be clearly distinguished — if possible by a different colour of piste — to make it easy for the fencers to be aware of their position on the piste (see Figures 1 and 2, pp. 9 and 10).

CHAPTER 4. THE FENCERS' EQUIPMENT

(Weapons — Equipment — Clothing)

Responsibility of fencers

- t.15.** 1. Fencers arm, equip and clothe themselves and fence **at their own responsibility** and **at their own risk**.
2. The **safety measures** specified in the Rules and in the standards contained in the annexe to them and the methods of control laid down in the present Rules (cf. Material Rules) are only designed to **increase** the fencers' safety and cannot **guarantee** it. They cannot, therefore, whatever the manner in which they are applied, impart

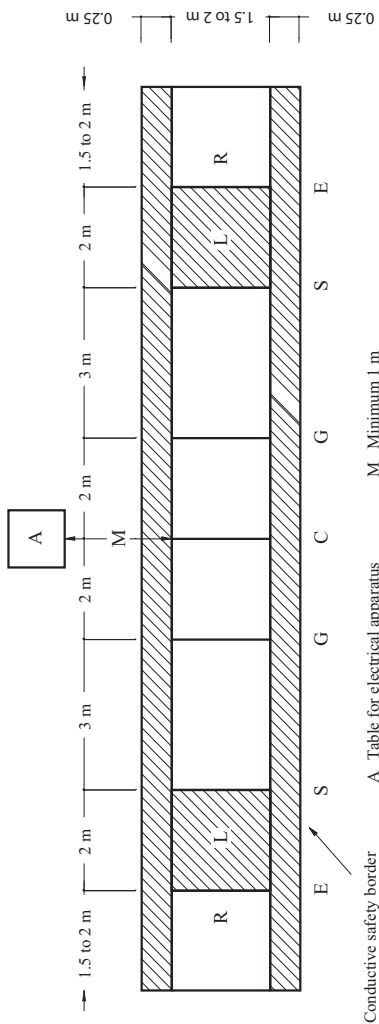

For foil and épée the conductive surface must cover the whole of the length and breadth of the piste, including its extensions (run back) and its safety borders (cf. Article t.1.3s, m.57)



1 Scoring apparatus 2 Extension lamps

Figure 1. Piste for semi-finals and finals (maximum height 50 cm)

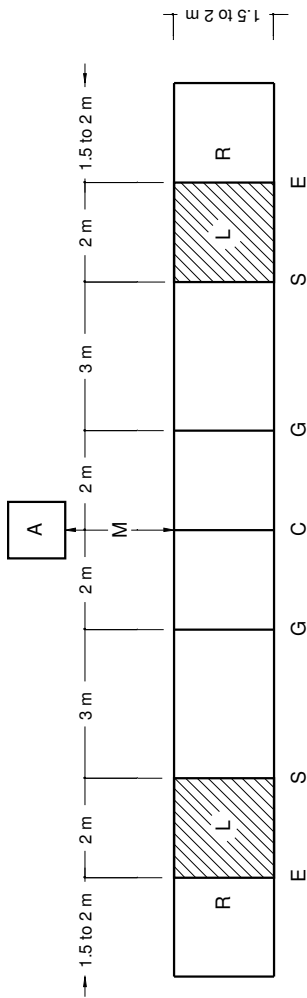

- A Table for electrical apparatus
- C Centre line
- G On-guard lines
- R Run back (extension of piste)
- M Minimum 1 m
- L Last 2 m of piste
- E End of piste (rear limit)
- S Start of 2 m signal area

For foil and épée the conductive surface must cover the whole of the length and breadth of the piste, including its extensions (run back) (cf. Article 1.13s, m.57)

Figure 2. Standard piste for all three weapons

responsibility to the FIE, or to the organisers of competitions, to the officials or personnel who carry out such organisation, or to those who may cause an accident.

CHAPTER 5. FENCING

Method of holding the weapon

- t.16. 1. With all three weapons, **defence** must be effected exclusively with the guard and the blade used either separately or together.
2. If the **handle** has no special device or attachment or special shape (e.g. orthopaedic), a fencer **may hold it** in any way he wishes and he may also alter the position of his hand on the handle during a bout. However, the weapon must not be — either permanently or temporarily, in an open or disguised manner — transformed into a **throwing weapon**; it must be used without the hand leaving the handle and without the hand slipping along the handle from front to back during an offensive action.
3. When the handle has a **special device** or **attachment** or has a **special shape** (e.g. orthopaedic) it must be held in such a way that the upper surface of the thumb is in the same plane as the groove in the blade (at foil or at épée) and perpendicular to the plane of flexibility of the blade at sabre.
4. The weapon must be used **with one hand only**; a fencer may not change hands until the end of the bout, unless the Referee gives special permission in the case of injury to the hand or arm.

Coming on guard

- t.17. 1. The fencer **whose number is called first** should place himself on the **right** of the Referee, except in the case of a bout between a right- and a left-hander, if the left-hander is called first.
2. **The Referee places** each of the two competitors in such a way that the front foot of each is 2 metres from the centre line of the piste (that is, behind the 'on-guard' lines).
3. Competitors are always put on guard, whether at the beginning of the bout or subsequently, **in the centre of the width of the piste**.
4. When placed on guard during the bout, the distance between the two competitors must be such that, in the position 'point in line', **the points of the two blades cannot make contact**.
5. **After the scoring of a valid hit** the competitors are put on guard **in the middle** of the piste.
6. **If no hit is awarded** they are replaced in the position which they occupied when the bout was interrupted.
7. At the beginning **of each period** (in a direct elimination bout) and of any **additional minute** of fencing time, the fencers are placed on guard in the middle of the piste.

8. The competitors may not be replaced **on guard, at their correct distance**, in such a way as to place behind the rear line of the piste a fencer who was in front of that line when the bout was halted. If he already had one foot behind the rear line, he remains in that position.
9. If a fencer has crossed the **lateral boundaries of the piste**, he may be put back on guard at the correct distance even if this places him behind the rear line and thereby causes a hit to be awarded against him.
10. Competitors come on guard when the Referee gives the order '**On guard!**', after which the Referee asks, '**Are you ready?**'. On receiving an affirmative reply, or in the absence of a negative reply, he gives the command for fencing to commence with the word '**Play!**'.
11. The fencers must **come on guard correctly** and remain **completely still** until the command '**Play!**' is given by the Referee.
12. At foil and sabre fencers may not come on guard in the '**in line**' position.

Beginning, stopping and restarting the bout

- t.18**
1. **The start** of the bout is signalled by the word '**Play!**'. No movement made or initiated before the word '**Play!**' is counted.
 2. The bout **stops** on the word '**Halt!**', except in the case of special events occurring which modify the regular and normal conditions of the bout (cf. also t.32.1/2).
 3. Directly the order '**Halt!**' has been given, a competitor may not start a new action; only a movement which has been begun before the order was given remains valid. Everything which takes place afterwards is entirely non-valid (But cf. t.32.1/2).
 4. If a competitor **stops** before the word '**Halt!**', and is hit, the hit is valid.
 5. The order '**Halt!**' is also given if the play of the competitors is **dangerous, confused, or contrary to the Rules**, if one of the competitors is **disarmed** or **leaves the piste**, or if, while retiring, he approaches too near the spectators or the Referee (cf. t.26, t.54.5 and t.73.4.j).
 6. The Referee may not allow a fencer to **leave the piste**, save in exceptional circumstances. If a competitor does so without permission he is liable to incur the penalties enumerated in Articles t.114, t.116, t.120.

Fencing at close quarters

- t.19.** **Fencing at close quarters** is allowed so long as the competitors can wield their weapons correctly and the Referee can, at foil and sabre, follow the phrase.

Corps à corps

- t.20.** 1. **Corps à corps** is said to exist when the two competitors are in contact; when this occurs the Referee must stop the bout (cf. t.25, t.63.1/2/3).

2. **At foil and at sabre** it is forbidden for a fencer to **cause corps à corps** (even without brutality or violence). Should such an offence occur, the Referee will penalise the fencer at fault as specified in Articles t.114, t.116, t.120, and any hit scored by the fencer at fault is annulled.
3. **At all three weapons** it is forbidden for a fencer to **cause corps à corps intentionally** to avoid being hit, or to jostle his opponent. Should such an offence occur, the Referee will penalise the fencer at fault as specified in Articles t.114, t.116, t.120 and any hit scored by the fencer at fault is annulled.

Displacing the target and passing the opponent

- t.21. 1. Displacing the target and ducking** are allowed even if during the action the unarmed hand comes into contact with the piste.
2. It is forbidden to **turn one's back** on one's opponent during the bout. Should such an offence occur, the Referee will penalise the fencer at fault as specified in Articles t.114, t.116, t.120 and any hit scored by the fencer at fault is annulled.
 3. When a fencer **goes past** his opponent during a bout, the Referee must immediately call 'Halt!' and replace the competitors in the positions which they occupied before the passing took place.
 4. When hits are made **as a fencer passes his opponent**, the hit made immediately is valid; a hit made after passing his opponent by the competitor who has made the passing movement is annulled, but the hit made immediately, even when turning round, by the competitor who has been subjected to the offensive action, is valid.
 5. If during a bout a fencer who has made a flèche attack has a hit registered against him and he continues to run beyond the extreme limit of the piste sufficiently far to cause his spool or the connecting line to his spool **to be torn out**, the hit which he has received will not be annulled (cf. t.103).

Substitution and use of the non-sword hand and arm

- t.22. 1. The use of the non-sword hand and arm** to carry out an offensive or defensive action is forbidden (cf. t.114, t.117, t.120). Should such an offence occur, the hit scored by the fencer at fault is annulled and the latter will be penalised as specified for offences of the 2nd group (red card).
2. At foil and sabre, it is forbidden to **protect** the target area or to **substitute** another part of the body for the target area, either by covering or by an abnormal movement (cf. t.114, t.116, t.120); any hit scored by the fencer at fault is annulled.
 3. During the fight, the fencer must not, under any circumstances, **take hold of any part of the electrical equipment** with his non-sword hand (cf. t.114, t.116, t.120); any hit scored by the fencer at fault is annulled.
- t.23. 1.** If during a bout the Referee notices that one of the fencers is making use of his non-sword arm and/or hand, or is protecting or covering

the valid target with a non-valid surface, he can call for the help of two **neutral judges** who will be designated by the Directoire Technique.

2. These judges, one on each side of the piste, will watch **all aspects of the fight** and will indicate, by raising their hand or when asked by the Referee, if the non-sword arm or hand has been used, or if the fencer has protected or covered the valid target with a non-valid surface (cf. t.49, t.114, t.116, t.120).
3. The Referee may also **make the fencers change places** so that the fencer committing this fault does not have his back to the Referee.

Ground gained or lost

- t.24. When the order 'Halt!' is given **ground gained** is held until a hit has been given. When competitors are replaced on guard, each fencer should retire an equal distance in order to keep fencing distance (cf. t.17.2/4).
- t.25. However, if the bout has been stopped on account of **corps à corps**, the fencers are replaced on guard in such a position that the competitor who has sustained the corps à corps is at the place which he previously occupied; this also applies if his opponent has subjected him to a **flèche** attack, even without corps à corps.

Crossing the limits of the piste

Stopping the bout

- t.26. 1. When a competitor **crosses one of the lateral boundaries** of the piste with **one or both feet**, the Referee must immediately call 'Halt!'.
2. If the fencer **goes off the piste with both feet**, the Referee must annul everything that has occurred after the boundary has been crossed, except a hit received by the competitor who has crossed the boundary even after he has crossed it, provided that this hit results from a simple and immediate action.
3. However, a hit scored by the fencer who **leaves the piste with one foot only** is valid provided that the action was started before the 'Halt!'.
4. If **one of the competitors** leaves the piste with **both feet**, only a hit made by the fencer who remains on the piste with at least one foot can be counted valid, even in the case of a double hit.

Rear limits

- t.27. Should a competitor cross the **rear limit** of the piste completely — i.e. with both feet — a hit will be scored against him.

Lateral boundaries

- t.28. 1. A competitor who crosses one of the **lateral boundaries** of the piste with one or both feet is penalised. When the competitors are replaced on guard, the opponent of the competitor who has crossed the lateral boundary will step forward one metre from the position he occupied

when his opponent left the piste; the competitor who is penalised must retire in order to resume the correct fencing distance.

2. **If the exercise of this penalty** places a competitor with both feet beyond the rear limit of the piste, that competitor is considered as having been hit.
3. A competitor who crosses one of the lateral boundaries of the piste with one or both feet — e.g. when making a flèche — **to avoid being hit** will be penalised as specified in Articles t.114, t.116, t.120.

Leaving the piste accidentally

- t.29. A competitor who **involuntarily** crosses one of the boundaries of the piste as the result of any accidental cause (such as jostling) incurs no penalty whatever.

Duration of the bout

- t.30. 1. Duration of the bout is held to mean the **effective duration**, that is the total of the intervals of time between the orders 'Play!' and 'Halt!'.
2. The duration of the bout is **registered** by the Referee or by a time-keeper. For the finals of all official competitions, as well as for all bouts for which a chronometer is visible to the spectators, the chronometer must be so placed that it is visible to the two fencers on the piste and to the Referee.
3. The effective **duration** of a bout is:
- For **pools**, 5 hits, maximum 3 minutes.
 - For **direct elimination** bouts, 15 hits, maximum 9 minutes divided into 3 periods of 3 minutes, with one minute's pause between any two periods.
 - For **team matches**, 3 minutes for each lap or bout.
- t.31. 1. The fencers may ask **how much time they have left** to fence each time that the fencing is interrupted.
2. Any fencer who attempts improperly to **cause or to prolong interruptions** to the bout is penalised as specified in Articles t.114, t.116, t.120.
- t.32. 1. **At the expiry of the regulation fencing time**, if the clock is linked to the scoring apparatus (obligatory standard for finals of official FIE competitions), it must set off automatically a loud audible signal, and automatically cut off the scoring apparatus, without cancelling hits registered before the disconnection. The bout stops with the audible signal.
2. **If the clock is not linked to the scoring apparatus**, the time-keeper must shout 'Halt!' (or operate a sound signal) which stops the fight; in this case even a 'coup lancé' is not valid.
3. Should there be a **failure of the clock** or an **error by the time-keeper**, the Referee must himself estimate how much fencing time is left.

Accidents, withdrawal of a competitor

- t.33. 1. For an **injury** which occurs in the course of a bout and which is properly attested by the delegate of the FIE Medical Committee or by the doctor on duty, the Referee will allow a break in the fight lasting no longer than 10 minutes. This break should be timed from the point when the doctor gave his opinion and be strictly reserved for the treatment of the accident which brought it about. If the doctor considers, before or at the end of the 10-minute break, that the **fencer is incapable of continuing** the fight, he will decide that the fencer should retire (individual events) and/or be replaced, if possible (team events) (cf. o.44.11.a/b).
2. During **the remainder of the same day**, a fencer cannot be allowed a further break unless as a result of a different injury.
3. Should a fencer **demand a break** which is deemed by the delegate of the Medical Committee or by the doctor on duty to be **unjustified**, the Referee will penalise that fencer as specified in Articles t.114, t.117, t.120.
4. **In team events** a fencer judged unable to continue the bout by the doctor may, nevertheless, on the advice of the same doctor, fight in subsequent matches on the same day.
5. The Directoire Technique may **modify the order of bouts** in a pool in order to ensure the efficient running of the competition (cf. o.16.1).

CHAPTER 6. REFEREEING AND JUDGING OF HITS

- t.34. 1. By accepting a position as referee or judge, the person so designated **pledges his honour** to respect the Rules and to cause them to be respected, and to carry out his duties with the strictest impartiality and absolute concentration.
2. Referees **may not combine** their function with any other activity during the tournament, such as member of the Directoire Technique, team captain, official delegate of their national federation, trainer, etc.

The Referee

- t.35. 1. All bouts at fencing are directed by a **referee who must be an FIE referee licensed for the current season**.
2. The Referee has many **duties**:
- He **calls the roll** of the competitors (cf. t.86.1, t.86.5/6).
 - He **directs** the bout.
 - Before each bout he must **check** the weapons, clothes and equipment of the fencers, according to the regulations below.
 - He **superintends** the proper functioning of the electrical apparatus. Either on his own initiative or when asked to do so by a team captain or competitor, he implements tests necessary to check

the apparatus and locate any faults which may be found. He will prevent the competitors from hindering the tests by unplugging or changing their equipment at the wrong moment.

- e) He **directs** the judges, time-keepers, scorers, etc.
- f) He positions himself and moves in such a way as to be able to **follow the bout** while always being able to see the illumination of the signal lamps.
- g) He **penalises** faults (cf. t.96.2).
- h) He **awards** the hits (cf. t.40ss).
- i) He **maintains** order (cf. t.96.1–4).
- j) Whenever he considers it necessary, he should **consult** the experts concerning the electrical apparatus (cf. o.7).

Judges

- t.36. 1. The Referee fulfils his functions with the aid of an apparatus for the automatic registering of hits; he may also be assisted by **two judges** watching for the use of the unarmed hand or arm, substitution of the valid target, hits scored on the floor at épée, leaving the piste to the side or the rear or any other offence defined in the Rules (cf. t.120).
2. The judges are **obligatory** for all individual competition finals (whether of 4 or 8 fencers) and for the **final** (2 teams) of team events.
3. The judges are placed on each side of the Referee, on either side of the piste; they watch **all aspects** of the entire fight.
4. The judges must **change ends** halfway through each bout or after each period in direct elimination bouts and after each bout in team matches, so as not to watch the same fencer the whole time.

Attribution of referees

Olympic Games and World Championships

Individual competitions

- t.37. 1. For the rounds of pools and the direct elimination table, **the Refereeing Delegates** select the referees by drawing lots.
2. **For the pools**, the referee must be of a different nationality from that any of the fencers in the pool.
3. For the **direct elimination tables at each weapon**, the Refereeing Delegates establish, among the referees present, a list of the best referees at each weapon (according to the grades obtained during the season).

For each quarter of the table, 4 referees are assigned by drawing lots from among at least 7 to 8 referees, to referee the bouts in the order of the table. They must be of a different nationality from that of any of the fencers participating in that quarter of the table.

As the table progresses, the referees will be switched around in a sequence established beforehand.

4. At the end of each round, the Refereeing Delegates can **withdraw a referee** whose performance was not satisfactory. This decision must be taken by the majority of the Refereeing Delegates present. However, a referee may not be changed during of a bout except in exceptional circumstance. In such a case the decision, which must be well founded, must be taken by the majority of the Refereeing Delegates present (this rule is equally valid for team competitions).

5. **For the final of 4**, the Refereeing Delegates, immediately after the end of the direct elimination tables, select 4 referees by lot from among at least **7 to 8** referees, who must be of a different nationality from any of the fencers.

10 minutes before the final, the Refereeing Delegates will draw lots to assign the referees for all the bouts at the same time, in the following order: 1st semi-final, 2nd semi-final, final, and 3rd place (Olympic Games).

6. **The drawing of lots is done** with the help of a computer for the pools and up to the direct elimination table of 64 and by hand from the direct elimination table of 64 onwards.

t.38. *Team competitions*

The same rules as those in article t.37 3), 4), 5) and 6) are applied to the team competitions, with two referees per match

World Cup competitions

- t.39. The Directoire Technique, assisted for finals by the Official **Supervisor** of the FIE, applies the rules described in Articles t.37 and t.38, above.

Method of judging hits

Materiality of the hit

- t.40. 1. The **materiality of the hit** is established according to the indications of the apparatus, and when necessary by consulting the judges (cf. t.36).
2. Only the **indications of the electrical apparatus** as indicated by its own lamps or by the extension lamps can be taken into consideration for judging hits. Under no circumstances can the Referee declare a competitor to be hit unless the hit has been properly registered by the apparatus (except as provided for in Article t.49.1 or when a penalty hit has been awarded).
- t.41. On the other hand, the Referee should, in the cases enumerated for each weapon, **annul** a hit registered by the apparatus (cf. t.53ss, t.66ss, t.73).

Validity or priority of the hit

- t.42. 1. As soon as the bout has stopped, the Referee briefly **analyses** the movements which composed the last fencing phrase.
2. For **finals**, the Referee may make use of a television monitor to check on his decision should he be uncertain.

3. After reaching his decision regarding the materiality of a hit, the Referee, **by applying the rules**, decides which fencer was hit, whether both were hit (épée), or whether there was no valid hit (cf. t.55ss, t.64ss, t.74ss).
4. The Referee must use the following **signals** (Figure 3, pp.20–21).

Regulation equipment and checking of equipment by the Referee

- t.43. 1. Before the start** of each pool, team match or bout by direct elimination, the Referee must assemble all the competitors and verify that (cf. t.35.2.c):
- a) at all weapons, the **FIE guarantee label** is present on the fencers' equipment (clothing, masks).
 - b) at foil, the **conductive jacket** conforms to the provision of Article m.28 when each competitor is standing upright, is on guard and is in the lunge position;
 - c) at épée, the material from which the clothing is made has not too smooth a surface, and the competitor is wearing a **jacket conforming to the regulations**;
 - d) at sabre, the **conductive jacket** conforms to the provision of Article m.34 when each competitor is standing upright, is on guard and is in the lunge position;
 - e) at all three weapons, each fencer is wearing, under his jacket, a regulation **protective under-plastron**, made of cloth which can resist 800 Newtons.
 - f) at all three weapons, the fencer is not equipped with any **electronic communication equipment** which would allow a person off the piste to communicate with the fencer during the bout.

In pools, this checking must be done at the roll call of the fencers.

For bouts in the direct elimination and the finals this checking must be done in the assembly area.

The organisers of all official FIE competitions (junior and senior) must make provision in their set-up for an assembly area.

2. For bouts in the **direct elimination** and the **finals** at the **World Championships and the Olympic Games**, and for **finals of World Cup competitions**, the two fencers in each bout will go to the equipment checking zone, located near the piste, 30 minutes before they are due on the piste. Their equipment will be checked under the responsibility of the SEMI (or the designated expert for finals of World Cup competitions). If any anomaly is identified the equipment at fault will be changed at once, without any penalty being applied. The SEMI delegate will hand over the bodywires, the masks and the weapons that have been checked to the Referee for the bout. **Ten minutes before** they are due on the piste the fencers will report to the Referee designated for their bout. The Referee will hand over a bodywire to each of the fencers in the access zone for the piste. He will check that the fencers are wearing regulation under-jacket protection.

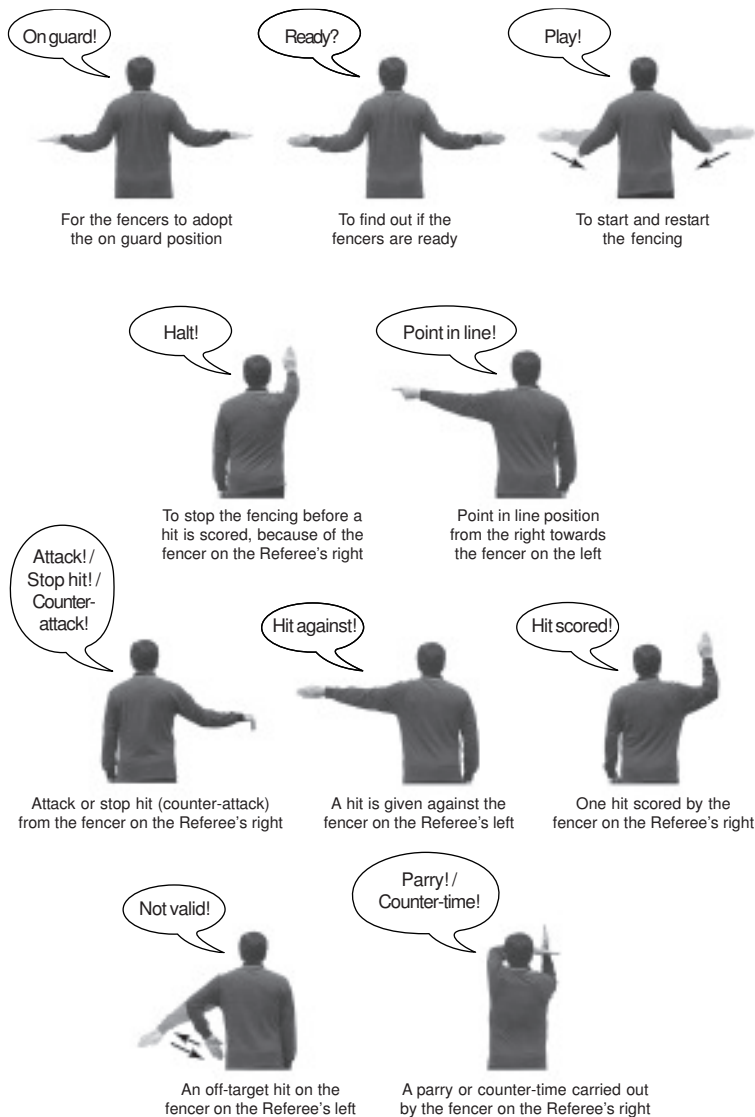
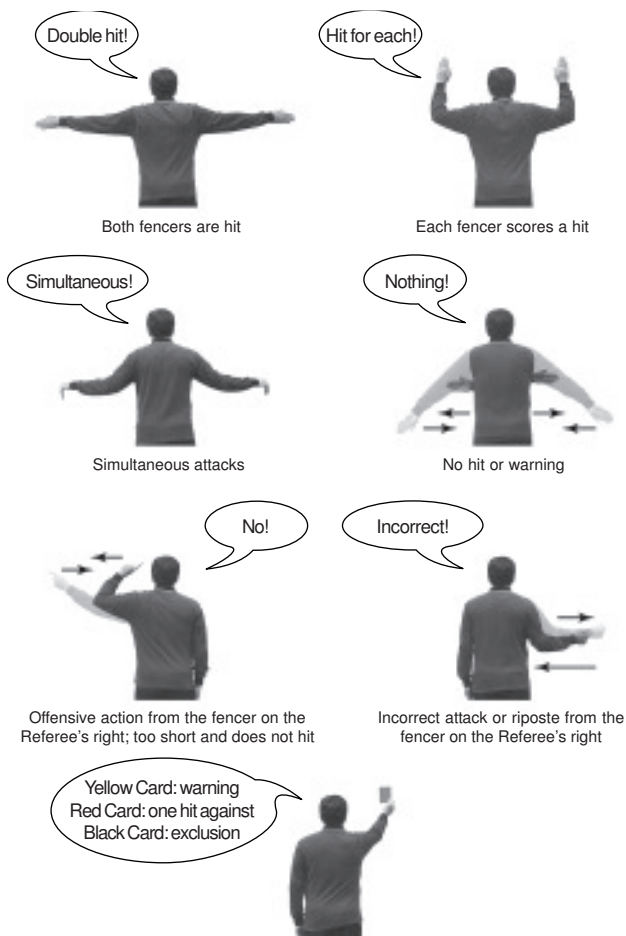

Figure 3. Referee signals and commands



By mimicry, the Referee demonstrates the offence of the fencer on the right and shows the card corresponding to the offence concerned

NOTES

1. The Referee analyses the fencing and announces his decisions by means of the signals and words above.
2. In following the fencing phrase the Referee uses the following words without making the signals: "Riposte!", "Counter-riposte!", "Remise!", "Reprise!", "Redouble!"
3. The fencers may politely ask the Referee for a more complete analysis of the fencing phrase.
4. Each signal must last 1–2 seconds, be expressive and be correctly made. Above they refer to the fencer on the Referee's right.

Figure 3. Referee signals and commands (contd.)

3. The Referee and the fencers must **stay together** in the access zone until they go on the piste. **One minute** before they go on the piste the Referee will give a weapon to each fencer, for him to plug in his bodywire. No check will be carried out on the piste prior to the bout.
 4. Competition organisers must organise a **waiting area where the fencers can warm up** during this checking procedure.
- t.44.**
1. **In addition to the checks mentioned above**, the Referee of a bout may at any time, on his own initiative or at the request of a fencer or of a team captain, carry out such checks, or verify the checks already carried out or even carry out, or have carried out, new checks (cf. t.35).
 2. He will in any case, before each bout, ensure that the **guarantee label** is present on the clothing, the blade and the mask of each fencer, and that the **insulation of the wires** inside the guard and the **pressure of the spring** in the point of foils and épées conform with the Rules. Checking the insulation of the wires and the pressure of the spring will be repeated each time a weapon is changed. At all three weapons, he will check that the fencer is not equipped with **electronic communication equipment** which would allow a person off the piste to communicate with the fencer during the bout.
 3. At épée he will check **the total travel and the residual travel** of the pointe d'arrêt:
 - He will check the **total travel** by inserting a gauge measuring 1.5 mm between the barrel of the pointe d'arrêt and the tip. This gauge, provided by the Organising Committee, may have a tolerance of ± 0.05 mm, i.e. from 1.45 mm to 1.55 mm.
 - He will check the **residual travel** by inserting a gauge measuring 0.5 mm between the barrel of the pointe d'arrêt and the tip. The apparatus should not register when the point is depressed. This gauge, provided by the Organising Committee, may have a tolerance of ± 0.05 mm, i.e. from 0.45 mm to 0.55 mm.
 4. For details of the **weight** used for the check, cf. m.11.3, m.19.3, m.42.2.d.
 5. At the beginning of the bout the Referee will place the **reserve equipment that has been checked** near the appropriate end of the piste for the fencer concerned.

Non-regulation equipment

- t.45.** In whatever circumstances a fencer on the piste is found to be in possession of equipment which is **non-regulation or defective** (cf. m.8, m.9, m.12, m.13, m.16, m.17, m.23), this equipment will be immediately confiscated and submitted to the experts on duty for examination. The equipment in question will only be returned to the owner after the measures necessitated by this examination have been completed and, if appropriate, after the payment of any expenses for repairs. The equipment must be rechecked before it is used again.

1. If a fencer appears on the piste:
 - with only **one** regulation **weapon** (cf. t.86.1/2); or
 - with only **one** regulation **bodywire**; or
 - with a **weapon or a bodywire** which **does not work** or which **does not conform** with the Rules; or
 - without his **protective under-plastron** (cf. t.43.1.e above); or
 - with a **conductive jacket** which does not fully cover the valid target; or
 - with **clothing** which does not conform with the Rules;
 the Referee will apply the penalties according to Articles t.114, t.116, t.120 (First Group).

2. When during a bout an irregularity is found in the equipment which could be caused by conditions **during the bout**:

Examples:

- conductive jacket with holes in which hits are registered as non-valid,
- weapon or bodywire no longer functioning,
- pressure of the spring in the point too weak,
- the travel in the point no longer regulation,

the Referee will apply **neither warning nor penalty** and any hit scored with the equipment which has become defective will be awarded.

However, even during the course of a bout, any fencer whose weapon, at the moment he presents himself on guard and ready to fence, has a **curve of the blade** which exceeds that permitted (cf. m.8.6, m.16.2, m.23.4) **commits an offence in the first group** and will be penalised in accordance with Articles t.114, t.116 and t.120.

3. a) If, when a fencer appears on the piste or during a bout, it is established that the equipment used by the fencer:
 - i) **does not bear the marks** applied at the preliminary check, the Referee will:
 - annul the last hit, if any, scored by the fencer at fault;
 - penalise him as specified in Articles t.114, t.117, t.120.
 - ii) does not conform to the rules in a way **not covered by the preliminary check**, the Referee will:
 - penalise him as specified in Articles t.114, t.116, t.120.
 - iii) has been passed by the preliminary check but presents irregularities which could have been **made deliberately**; or
 - iv) bears the marks of the preliminary check which have been **imitated or transferred**; or
 - v) has been altered in any way to allow the recording of hits or the nonfunctioning of the apparatus **at will**; or

- vi)** is equipped with **electronic communication equipment** permitting a person off the piste to communicate with the fencer during the bout; then,
- in cases **iii), iv), v) and vi) above**, the Referee must immediately **confiscate** the equipment (weapon, bodywire, if necessary conductive jacket, mask, etc.), and have it examined by the expert on duty.
- b)** After having obtained the **opinion of the expert** (a member of the Committee for Electrical Apparatus and Equipment at the fencing events at the Olympic Games and at World Championships), who has established the facts (cf. m.33ss), the Referee will apply the following **sanctions**, without prejudice to the application of Article t.96.2/4;
- in cases **iii)** and **iv)** the Referee will penalise him as specified in Articles t.114, t.118, t.120, and annul the last hit, if any, scored by the fencer at fault.
 - in cases **v)** and **vi)** the Referee will penalise him as specified in Articles t.114, t.119, t.120.
- c)** **While awaiting the decision** of the Referee that bout will be suspended but the other bouts in the pool may continue.
- 4.** Every fencer must appear on the piste with clothing **conforming to the rules** as follows:
- a)** **Name and nationality**, in accordance with the rules, on the back of the jacket. *Application: all official FIE competitions, at all stages of the competitions.*
- b)** Wearing his **national uniform** (cf. m.25.3). *Application as follows:*
- i)** **Open, Junior and Cadet World Championships**, all bouts, whether in a pool, in the direct elimination or during a team match;
 - ii)** **Individual Senior World Cup competitions**, all direct elimination bouts from the 64 onwards;
 - iii)** **World Cup team competitions**, all bouts in every match.

In case of violation of this rule:

- For the competitions mentioned in items **i)** and **iii)** above, the Referee shall **eliminate** the fencer at fault, and he will not be allowed to participate further in the event.
- For the competitions mentioned in item **ii)** above, the Referee shall penalise the fencer at fault with a Red Card (Articles t.114, t.117, t.120, Second Group). The fencer at fault shall however be **allowed to remain** on the piste and fence the bout concerned.

The same penalty is also applied for the absence of name and nationality, in accordance with the rules, on the back of the jacket at Junior World Cup competitions, at Individual Senior World

Cup competitions before the last 64, and at Zonal Championships.

5. If the conductive jacket does not conform to the rules, the fencer must put on a spare jacket that does conform to the rules. If this jacket does not have his name and nationality on the back, the fencer has until the next stage of the competition (from the pools to the table of 64, the table of 32, etc) to get his name and nationality printed on it.

If this is not done and except in cases of 'force majeure' the referee will eliminate the fencer and he cannot continue to participate in the competition.

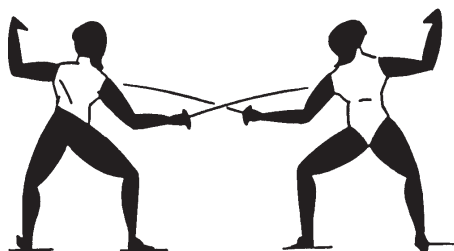

Figure 4. Valid target at foil

PART 2. FOIL

THE CONVENTIONS OF FENCING

METHOD OF MAKING A HIT

- t.46.** 1. The foil is a **thrusting** weapon only. Offensive actions with this weapon are made therefore with the point and with the point only.
2. **Pushing or letting drag** the point of the electric weapon on the electric piste is forbidden during the actual bout (between 'Play!' and 'Halt!'). Placing the weapon on the piste at any time to **straighten** it is also forbidden. Any breaking of these rules will be punished according to Articles t.114, t.116, t.120.

TARGET

Limitation of the target

- t.47.** 1. At foil, only hits which arrive **on the target** are counted as valid.
2. **The target** at foil excludes the limbs and the head. It is confined to the trunk, the upper limit being the collar up to 6 cm above the prominences of the collar bones; at the sides to the seams of the sleeves, which should cross the head of the humerus; and the lower limit following a horizontal line across the back joining the tops of the hip bones, thence by straight lines to the junction of the lines of the groin (see Figure 4, above).

Hits off the target

- t.48.** A hit which is made on a part of the body **other than the target** (whether directly or as a result of a parry) is not counted as a valid hit, but it stops the phrase and therefore annuls all hits which are scored thereafter (but cf. t.49).

Extension of the valid target

- t.49.** 1. However, hits which arrive off the target are counted as valid whenever, by reason of an **abnormal position**, the fencer has substituted this non-valid target for the valid target.
2. The Referee may question the judges about this, but he **alone** must decide whether the hit is valid or not.

JUDGING OF HITS AT FOIL

- t.50.** Foil competitions are judged with an **electrical recording apparatus**.

MATERIALITY OF THE HIT

- t.51.** **Only the indications of the recording apparatus** can be taken into consideration for judging the materiality of hits. The Referee cannot declare a competitor to be hit unless the hit has been properly registered by the apparatus (except as provided for in Article t.49.1, or when a penalty hit has been awarded).
- t.52.** When using the apparatus it should be noted that:
- If a **non-valid hit** has been scored the apparatus will not register a possible valid hit scored on the same side of the apparatus.
 - The apparatus does not indicate whether there is any **priority in time** between two or more hits which it registers simultaneously.

ANNULMENT OF A HIT

- t.53.** 1. The Referee will **disregard** hits which are registered as a result of actions:
- started **before the word ‘Play!’** or **after the word ‘Halt!’** (cf. t.18.1/3);
 - which are made on any object **other than the opponent** or his equipment (cf. t.41).
2. A competitor who, **intentionally**, causes the apparatus to register a hit by placing his point on the ground or on any surface **other than that of his opponent** will be penalised as specified in Articles t.114, t.117, t.120.
3. Fencers are forbidden to place a **non-insulated part** of their weapon in contact with their conductive jacket with the intention of jamming the electrical apparatus and thus avoiding being hit.
- The penalty for committing such an offence is specified in Articles t.114, t.116, t.120. Any hit scored by the fencer at fault is annulled.
- t.54.** 1. The Referee must, on the other hand, take into account **possible failures of the electrical equipment**, in particular:
- He must **annul a hit which he has just awarded** as a result of a hit signalled as on the valid target (coloured lamp) if he establishes, by tests made under his personal supervision, before the

bout has effectively recommenced (the command 'Play!') and without any of the equipment in use having been changed (cf. t.35.2/d):

- either that a **hit registered as 'valid'** against the competitor against whom the hit has been awarded can be made without there being in fact a valid hit;
 - or that a **'non-valid' hit** made by the fencer against whom the hit was awarded is not registered by the apparatus;
 - or that a **'valid' hit** made by the fencer against whom the hit was awarded does not cause any hit either valid or non-valid to be registered;
 - or that the registration of hits **made by the competitor against whom the hit was awarded** does not remain recorded on the apparatus.
- b) On the other hand, when the Referee has decided that a hit made by a competitor has priority, this hit **shall not be annulled** if subsequently it is found that a valid hit made by the opponent is registered as non-valid or that the weapon of the fencer against whom the hit was awarded is permanently registering a non-valid hit.
- c) If a fencer's **equipment does not conform** to the provisions of Articles m.27 and m.28.3, a hit made off the target which is registered by the apparatus as valid will not be annulled.
2. The Referee must also apply the following rules:
- a) Only the **last hit** made before the fault was established can be annulled.
 - b) A competitor who **makes any modification in or who changes his equipment** without being asked by the Referee to do so, before the Referee has given his decision, loses all right to the annulment of the hit (cf. t.35.2.d).
 - c) **If the bout has effectively recommenced** a competitor cannot claim the annulment of a hit awarded against him before the said recommencement of the bout.
 - d) **The location of a fault** found in the equipment (including the equipment of the competitors) is of no importance for this possible annulment.
 - e) It is not necessary that **the failure found should repeat itself each time** a test is made; but it is essential that the fault should be manifested to the Referee without the possibility of doubt at least once during the tests made by him or under his supervision.
 - f) When a competitor against whom a hit has been registered has **broken his blade**, the hit must be annulled unless the breaking of the blade has occurred clearly after the hit has been registered.

- g) The Referee must pay particular attention to **hits which do not register or which are registered abnormally**. Should such defects be repeated, the Referee must ask a member of the Committee for Electrical Apparatus and Equipment or an expert technician on duty to verify that the equipment conforms to the Rules.
 - h) The Referee must ensure that **nothing is altered in the competitors' equipment** or in the whole of the electrical apparatus before the expert carries out his check.
3. Whenever accidental causes make it impossible to carry out tests, the hit will be considered **doubtful** and annulled.
 4. If hits are registered simultaneously **on both sides of the apparatus**, and the Referee cannot establish the priority with certainty, he must replace the competitors on guard.
 5. In accordance with the general rules (cf. t.18.5) the Referee must **stop the bout**, even if no hit is registered by the apparatus, whenever play becomes **confused** and he is no longer able to analyse the phrase.
 6. The Referee should also supervise **the state of the conductive piste**; he must not allow the bout to commence or to continue if the conductive piste has holes in it which might affect the proper registering of hits. (The organisers must make the necessary arrangements to ensure the rapid repair or replacement of the conductive piste.)

VALIDITY OR PRIORITY OF THE HIT

Preface

- t.55.** The Referee **alone** decides as to the validity or the priority of the hit by applying the following basic rules which are the conventions applicable to foil fencing.

Respect of the fencing phrase

- t.56.** **1.** Every **attack**, that is every initial offensive action, which is correctly executed must be parried or completely avoided and the phrase must be followed through — that is to say, co-ordinated (cf. t.7.1).
- 2.** In order to judge **the correctness of an attack** the following points must be considered:
- a) **The simple attack, direct or indirect** (cf. t.8.1), is correctly executed when the straightening of the arm, the point threatening the valid target, precedes the initiation of the lunge or the flèche.
 - b) **The compound attack** (cf. t.8.1) is correctly executed when the arm is straightened in the presentation of the first feint, with the point threatening the valid target, and the arm is not bent during the successive actions of the attack and the initiation of the lunge or the flèche.
 - c) The attack with a **step-forward-lunge** or a **step-forward-flèche** is correctly executed when the straightening of the arm precedes

the end of the step forward and the initiation of the lunge or the flèche.

- d) Actions, simple or compound, steps or feints which are **executed with a bent arm**, are not considered as attacks but as preparations, laying themselves open to the initiation of the offensive or defensive/offensive action of the opponent (cf. t.8.1/3).
3. To judge **the priority of an attack** when analysing the fencing phrase, it should be noted that:
- a) If the attack is initiated **when the opponent is not ‘point in line’** (cf. t.10), it may be executed either with a direct thrust, or by a disengage, or by a cut-over, or may even be preceded by a beat or successful feints obliging the opponent to parry.
 - b) If the attack is initiated **when the opponent is ‘point in line’** (cf. t.10), the attacker must, first, deflect the opponent’s blade. Referees must ensure that a mere contact of the blades is not considered as sufficient to deflect the opponent’s blade (cf. t.60.5.a).
 - c) If the attacker, when attempting to deflect the opponent’s blade, fails to find it (**dérobement**), the right of attack passes to the opponent.
 - d) **Continuous steps forward, with the legs crossing one another**, constitute a preparation and on this preparation any simple attack has priority.
- t.57. The parry gives the right to riposte: **the simple riposte** may be direct or indirect, but to annul any subsequent action by the attacker, it must be executed immediately, without indecision or delay.
- t.58. When a compound attack is made, if the opponent **finds the blade during one of the feints**, he has the right to riposte.
- t.59. When **compound attacks** are made, the opponent has the right to **stop-hit**; but to be valid the stop hit must precede the conclusion of the attack by an interval of fencing time; that is to say that the stop hit must arrive before the attacker has begun the final movement of the attack.

Judging of hits

- t.60. In applying these basic conventions of foil fencing, the Referee should judge as follows:
- 1. When, during a phrase, both fencers are **hit simultaneously**, there is either a *simultaneous action* or a *double hit*.
 - 2. The **simultaneous action** is due to simultaneous conception and execution of an attack by both fencers; in this case the hits exchanged are annulled for both fencers even if one of them has been hit off the target.
 - 3. The **double hit**, on the other hand, is the result of a faulty action on the part of one of the fencers.

Therefore, when there is not a period of fencing time between the hits:

4. Only the fencer who is attacked is counted as hit:

- a) If he makes a **stop hit** on his opponent's simple attack;
- b) If, instead of parrying, he attempts **to avoid the hit** and does not succeed in so doing;
- c) If, after making a successful parry, he makes a **momentary pause** which gives his opponent the right to renew the attack (redoublement, remise or reprise);
- d) If, into a compound attack, he makes a **stop hit** without being in time;
- e) If, **having his 'point in line'** (cf. t.10) and being subjected to a beat or a taking of the blade (prise de fer) which deflects his blade, he attacks or places his point in line again instead of parrying a direct thrust made by his opponent.

5. Only the fencer who attacks is counted as hit:

- a) If he initiates his attack **when his opponent has his point in line** (cf. t.10) without deflecting the opponent's weapon. Referees must ensure that a mere contact of the blades is not considered as sufficient to deflect the opponent's blade.
- b) If he attempts to find the blade, does not succeed (is the object of a **dérobement**) and continues the attack.
- c) If, during a compound attack, his opponent **finds the blade**, but he continues the attack and his opponent ripostes immediately.
- d) If, during a compound attack, he makes a **momentary pause**, during which time the opponent makes a stop hit, while the attacker continues his attack.
- e) If, during a compound attack, he is **stop-hit** in time before he begins his final movement.
- f) If he makes a hit by a remise, redoublement or reprise when his original attack has been **parried and his opponent has made a riposte** which is **immediate**, simple, and executed in one period of fencing time without withdrawing the arm.

6. The Referee must replace the competitors on guard each time that there is a double hit and he is unable to judge clearly on which side the fault lies.

One of the most difficult cases to judge arises when a stop hit is made and there is doubt as to whether it was made sufficiently in time in relation to the final movement of a compound attack. Generally, in such cases, the double hit occurs through the fault of both fencers concerned, which justifies the Referee replacing them on guard. (The fault of the attacker consists of indecision, slowness of execution or the making of feints which are not sufficiently effective. The fault of the defender lies in delay or slowness in making the stop hit.)

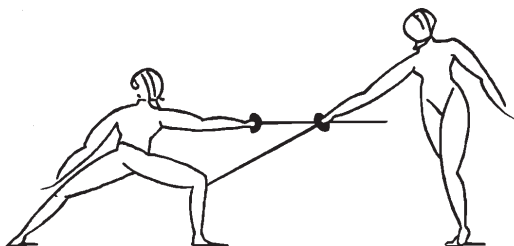

Figure 5. Valid target at épée

PART 3. EPEE

THE CONVENTIONS OF FENCING

METHOD OF MAKING A HIT

- t.61.** 1. The épée is a **thrusting weapon** only. Attacks with this weapon are therefore made with the point, and with the point only.
2. **Pushing** or letting the point of the electric weapon **drag** on the electric piste is forbidden during the actual bout (between 'Play!' and 'Halt!'). Placing the weapon on the piste at any time to **straighten** it is also forbidden.

Any breaking of this rule will be penalised according to Articles t.114, t.116, t.120.

THE TARGET

- t.62.** At épée the target includes the whole of the fencer's body including his clothing and equipment.

Thus any hit which arrives is counted, whatever part of the body (trunk, limbs or head), the clothing or the equipment it touches (see Figure 5, above).

CORPS A CORPS AND FLECHE ATTACKS

- t.63.** 1. At épée a fencer who either by a flèche attack or by advancing vigorously brings about a **corps à corps** even several times in succession (**without brutality or violence**) does not transgress the basic conventions of fencing and commits no fault thereby (cf. t.20.1/3, t.25).
2. A fencer who **intentionally causes corps à corps** to avoid being hit or who jostles his opponent is penalised according to Articles t.114, t.116, t.120.
3. The 'flèche ending systematically in a corps à corps' referred to in this article must not be confused with the 'flèche resulting in a shock

which jostles the opponent', which is considered as an act of **intentional brutality** at all three weapons and is punished as such (cf. t.87.2, t.120).

4. On the other hand the '**flèche** which is made by running, even going past the opponent', and **without a corps à corps**, is not forbidden: the Referee should not call 'Halt!' too soon, in order not to annul a possible riposte; if, when making such a running flèche without hitting his opponent, the fencer who makes the flèche crosses the lateral boundaries of the piste, he must be punished as laid down in Article t.28.3.

JUDGING OF HITS AT EPEE

- t.64. 1. Épée competitions are judged with an **electrical recording apparatus**.
2. When both competitors are hit, and the apparatus registers both these hits as valid, there is a **double hit**, that is to say a hit is scored against each competitor.

Basic principle

- t.65. 1. Only the **indications of the electrical recording apparatus** can be taken into consideration for judging the materiality of hits. The Referee cannot declare a competitor to be hit unless the hit has been properly registered by the apparatus (except when a penalty hit has been awarded).

The annulment of hits

- t.66. 1. In arriving at his judgement, the Referee will disregard hits which are registered as a result of actions:
 - started before the word '**Play!**' or after '**Halt!**' (cf. t.18.1/3);
 - caused by the **meeting of the points** of the épées or by a hit made on the **ground** where it is **not insulated**;
 - or which are made on any object **other than the opponent**, including his equipment (cf. t.36.1, t.67.e).
 2. Any competitor who, intentionally, causes the apparatus to register a hit by placing his point on any surface **other than that of his opponent**, will be penalised as specified in Articles t.114,t.117, t.120.
- t.67. The Referee must take note of **possible failures** of the electrical equipment and must annul the last hit registered in the following circumstances:
 - a) If a hit **made on the guard** of the competitor against whom the hit was registered or on the **conductive piste** causes the apparatus to register a hit;
 - b) If a hit **properly made** by the competitor against whom the hit was registered does not cause the apparatus to register a hit;
 - c) If the apparatus **fortuitously registers a hit** on the side of the competitor against whom the hit was registered, for example,

after a beat on the blade, by any movements of his opponent, or as a result of any cause other than a properly made hit;

- d) If the registering of a hit made by the competitor against whom the hit was registered is **annulled** by a subsequent hit made by his opponent.
- e) Special cases
 - If a double hit is registered and **one hit is valid and the other is not valid** (such as a hit made on some surface other than on the opponent (cf. t.66.1) or a hit made after leaving the piste (cf. t.26ss), only the valid hit is scored.
 - If a double hit is registered by **an established hit and a doubtful hit** (failure of the electrical apparatus) the fencer who has made the established hit may choose to accept the double hit or ask to have it annulled.

t.68. The Referee must also apply the following rules regarding the annulment of hits:

- a) **Only the last hit** which precedes the establishment of the failure of the apparatus may be annulled and then only if it is the competitor against whom the hit was registered who is placed at a disadvantage by the failure.
- b) **The failure** must be determined by tests made immediately after the bout was stopped, under the supervision of the Referee and without changing anything whatever of the equipment in use.
- c) With these tests, one is trying only to establish whether there is **material possibility** of a mistake in the judgement as a result of a fault. **The location of this fault** in the electrical equipment, including that of either of the fencers, is unimportant in reaching a decision.
- d) A competitor who makes any **modification** in, or **changes** his equipment without being asked by the Referee to do so, before a judgement is pronounced, loses his right to the annulment of the hit (cf. t.35.2.d). Similarly, after again coming on guard and after the bout has effectively recommenced, a competitor cannot claim the annulment of a hit registered against him before the said recommencement of the bout.
- e) It is not necessary, in order to justify the annulment of a hit, that **the failure found should repeat itself** each time a test is made, but it is essential that the fault should be established by the Referee without the possibility of doubt at least once.
- f) If the incidents mentioned in Article t.67 occur as a result of the competitor's **bodywire being unplugged** (either near the hand or at the back of the fencer), they cannot justify the annulment of the hit registered.

However, if the safety device prescribed by Article m.55.4 is missing or not functioning, the hit should be annulled if the plug at the fencers' back has become unplugged.

- g) The fact that the *épée* of a competitor has large or small **areas of insulation** formed by oxidation, by glue, paint or any other material on the guard, on the blade or elsewhere, on which his opponent's hits can cause a hit to be signalled, or that the **electric tip** is **badly fixed** to the end of the blade so that it can be unscrewed or tightened by hand, cannot justify the annulment of hits registered against that competitor.
- h) When a competitor against whom a hit has been registered has **broken his blade**, the hit must be annulled unless the breaking of the blade has occurred clearly after the hit has been registered.
- i) If a competitor **tears the conductive piste** by a hit made on the ground and, at the same time, the apparatus registers a hit against his opponent, the hit must be annulled.
- j) Whenever, owing to some accidental cause, tests cannot be made, the hit must be considered as **doubtful** and must be annulled (but cf. t.67.e).
- k) The Referee must pay particular attention to hits which **do not register** or which **are registered abnormally**. Should such defects be repeated, the Referee must ask the members of the Committee for Electrical Apparatus and Equipment present or an expert technician on duty to verify that the equipment conforms to the Rules.

The Referee must ensure that **nothing is altered** either in the competitor's equipment or in the whole of the electrical apparatus before the expert makes the check.

- t.69.** The Referee must supervise the **condition of the conductive piste**; he must not allow the bout to commence or to continue if the conductive piste has holes in it which might affect the proper registering of hits or cause accidents. (The organisers must make the necessary arrangements to ensure the rapid repair or replacement of the conductive pistes.)

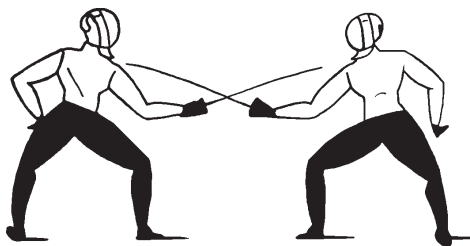

Figure 6. Valid target at sabre

PART 4. SABRE

THE CONVENTIONS OF FENCING

METHOD OF MAKING A HIT

- t.70.** 1. The sabre is a weapon for **thrusting** and **cutting** with both the **cutting edge** and the **back** of the blade.
2. All hits made with the **cutting edge**, the **flat** or the **back** of the blade are counted as good (cuts and back-cuts).
3. It is forbidden to **hit with the guard**. Any hits caused by hitting with the guard must be annulled, the fencer so hitting being penalised as specified in Articles t.114, t.116, t.120.
4. Point hits which **slip** over the valid target, or cuts which merely **brush** the opponent's target (passé hits) do not count.
5. Hits **through the blade**, that is to say those which touch at the same time the valid target and the sabre of the opponent, are valid whenever they arrive clearly on the target.
6. **Placing the weapon on the piste** at any time to **straighten** it is forbidden. Any breaking of this rule will be punished according to Articles t.114, t.116, t.120.

THE TARGET

- t.71.** Only hits which arrive on the target are counted as valid.
- The **target** comprises any part of the body above a horizontal line drawn between the top of the folds formed by the thighs and by the trunk of the fencer when in the on-guard position (see Figure 6, above).
- t.72.** 1. A hit which arrives on a **non-valid part** of the target is not counted as a hit; it does not stop the fencing phrase and does not annul any subsequent hits.

2. If a fencer **substitutes a non-valid part of his target for a valid part**, either by covering it or by any abnormal movement, the Referee must penalise him by applying the penalties specified in Articles t.114, t.116, t.120, and any hit scored by the fencer at fault is annulled.

JUDGING OF HITS AT SABRE

MATERIALITY AND ANNULMENT OF HITS

- t.73. Competitions at sabre are judged with the help of an **electric apparatus registering hits**.
 1. To judge the materiality of a hit, **only hits signalled by the registering apparatus** may be taken into account. The Referee cannot award a hit unless it has been properly registered by the apparatus, except for penalty hits. He will not take account of hits scored by movements started before 'Play!' or after 'Halt!' (cf. t.18.1–3).
 2. However, the Referee must take into account any **possible malfunctions** in the electrical equipment; in particular he must **annul a hit** he has just awarded in accordance with a signal from the apparatus if it can be established, by tests carried out under his attentive supervision, before the bout **has effectively re-started** and with no changes having been made to the equipment (cf. t.35.2.d):
 - that a hit made by the fencer judged to have been hit **does not cause the apparatus to register**;
 - that a hit made by the fencer judged to have been hit **does not remain fixed** on the apparatus;
 - that the **signal of a hit** against the fencer judged to have been hit can be produced either without there having been in fact a valid hit, or by a hit on the weapon or on a non-valid surface.
 3. If the **sabre** of the fencer judged to have been hit **does not conform** with Article m.24.6–8 (insulation of the interior and exterior of the guard, of the handle and of the pommel), there will be no annulment, even if a hit on the weapon causes a signal to register.
 4. The Referee should also apply the following rules:
 - a) **Only the last hit** made before the fault was established can be annulled.
 - b) A competitor who makes any **modification in** or who **changes** his equipment without being asked by the Referee to do so, before the Referee has given his decision, loses all right to the annulment of the hit (cf. t.35.2.d).
 - c) If the bout has **effectively recommenced**, a competitor cannot claim the annulment of a hit awarded against him before the said recommencement of the bout.
 - d) The **location of a fault** in the equipment (including the equipment of the competitors) has no bearing on whether or not a hit should be annulled.

- e) It is not necessary that a fault should **repeat itself every time** a test is made; but it is essential that the fault should be manifested to the Referee without the possibility of doubt at least once during the tests made by him or under his supervision.
- f) When a competitor against whom a hit has been registered has **broken his blade**, the hit must be annulled unless the breaking of the blade has occurred clearly after the hit has been registered.
- g) The Referee must pay particular attention to hits which **do not register** or are **registered abnormally**. Should such defects be repeated, the Referee must ask a member of the Committee for Electrical Apparatus and Equipment, or an expert technician on duty, to verify that the equipment conforms to the Rules.
- h) Whenever accidental causes make it impossible to carry out tests, the hit will be considered **doubtful** and therefore annulled.
- i) If there are signals on **both sides of the apparatus**, the Referee will apply the rules in Article t.80.
- j) In accordance with the general rules (cf. t.18.5) the Referee must **stop the bout**, even if no hit is registered on the apparatus, whenever the fencing becomes **confused** and he is no longer able to analyse the phrase.

VALIDITY OR PRIORITY OF THE HIT

Preface

- t.74.** The Referee **alone** decides as to the validity or the priority of the hit by applying the following basic rules which are the conventions applicable to sabre fencing.

Respect of the fencing phrase

- t.75.** 1. **Any attack properly executed** (cf. t.7) must be parried, or completely avoided, and the phrase must be followed through.
2. The attack is **correctly carried out** when the straightening of the arm, with the point or the cutting edge continuously threatening the valid target, precedes the initiation of the lunge.
3. **An attack with a lunge is correctly carried out:**
- a) in a **simple attack** (Cf. t.8.1) when the beginning of the straightening of the arm precedes the launching of the lunge and the hit arrives at the latest when the front foot hits the piste;
 - b) in a **compound attack** (Cf. t.8.1) when the beginning of the straightening of the arm, on the first feint (Cf. t.77.1), precedes the launching of the lunge and the hit arrives at the latest when the front foot hits the piste.

4. An **attack with a step-forward-lunge** is correctly carried out:
- a) in a **simple attack** (Cf. t.8.1) when the beginning of the straightening of the arm precedes the step-forward and when the hit arrives at the latest when the front foot hits the piste;
 - b) in a **compound attack** (Cf. t.8.1) when the beginning of the straightening of the arm for the first feint (Cf. t.77.1) precedes the step-forward, followed by the lunge, and the hit arrives at the latest when the front foot hits the piste.
5. **The flèche and any forward movement crossing the legs** or feet is forbidden. Any offence will be penalised as specified in Articles t.114, t.116, t.120. Any hit scored by the fencer at fault will be annulled. However, any hit correctly executed by his opponent is valid.
- t.76. In order to judge as to the correctness of an attack the following points must be considered:
- a) If the attack is initiated when **the opponent has his point ‘in line’** (cf. t.10) the attacker must first deflect his opponent’s weapon. Referees must ensure that a mere contact of the blades is not considered as sufficient to deflect the opponent’s blade.
 - b) If, when attempting to find the opponent’s blade to deflect it, the blade is not found (**dérobement**), the right of attack passes to the opponent.
 - c) If the attack is commenced when the **opponent’s blade is not ‘in line’**, the attack may be completed either direct, or by a disengagement or by a cutover, or else be preceded by feints (cf. t.77.1) which oblige the opponent to parry.
- t.77. 1. In **compound attacks** the feint must be correctly carried out, i.e.:
- a) A **feint with the point**, with the arm straightened and the point threatening the target continuously.
 - b) A **feint with a cut**, the arm straightened, the blade and the arm forming an obtuse angle of about 135°, with the cutting edge threatening a valid part of the target.
2. If during a compound attack the opponent **finds the blade during one of the feints**, he has the right to riposte.
 3. In a compound attack the opponent has the right to stop-hit; but, in order to be valid, the stop hit must precede the last movement of the attack by one period of fencing time, i.e. the **stop hit** must arrive before the attacker has started the last movement of the attack itself.
- t.78. **Attacks by beats** on the blade:
- a) In an attack by beating on the blade, this attack is correctly carried out and retains its priority when the beat is made on the **foible** of the opponent’s blade, i.e. the two-thirds of the blade furthest from the guard.

- b) In an attack by beating on the blade, when the beat is made on the **forte** of the opponent's blade, i.e. the one-third of the blade nearest the guard, the attack is badly executed and the beat gives the opponent the right to an immediate riposte.
- t.79.**
1. The parry gives the right to **riposte**; a simple riposte may be direct or indirect, but in order to annul any subsequent movement by the attacker, it must be carried out immediately, without any hesitation or pause.
 2. Against cuts with the **cutting edge**, the **flat** or the **back** of the blade, the object of the parry is to prevent hits made by the opponent arriving on the valid target; therefore:
 - a) The parry is **properly carried out** when, before the completion of the attack, it prevents the arrival of that attack by closing the line in which that attack is to finish.
 - b) When a parry is properly executed, the attack by the opponent must be declared parried, and judged as such by the Referee, even if, **as a result of its flexibility**, the tip of the opponent's weapon makes contact with the target.

Judging of hits

t.80. In applying these basic conventions of sabre fencing, the Referee should judge as follows.

1. When during a phrase both fencers are hit simultaneously there is either a **simultaneous action** or a **double hit**:

The simultaneous action is due to simultaneous conception and execution of an attack by both fencers; in this case the hits exchanged are annulled for both fencers.

2. The double hit (coup double) on the other hand, is the result of a clearly faulty action on the part of one of the fencers.

Therefore, when there is not an interval of fencing time between the hits:

3. **The fencer who is attacked** is alone counted as hit:
 - a) If he makes a **stop hit** on his opponent's simple attack;
 - b) If, instead of parrying, he attempts to **avoid** the hit and does not succeed in so doing;
 - c) If, after making a successful parry, he makes a **momentary pause** (delayed riposte) which gives his opponent the right to renew the attack (redoublement, or remise or reprise);
 - d) If, during a compound attack, he makes a **stop hit** without being in time;
 - e) If, having his **point 'in line'** (cf. t.10) and being subjected to a beat or a taking of the blade (prise de fer) which deflects his

blade, he attacks or places his point in line again instead of parrying a direct hit made by his opponent.

4. The fencer who attacks is alone counted as hit:

- a) If he initiated his attack when **his opponent had his point 'in line'** and without deflecting the opponent's weapon. Referees must ensure that a mere contact of the blades is not considered as sufficient to deflect the opponent's blade.
- b) If he attempts to find the blade, does not succeed (because of a **derobement**) and continues the attack.
- c) If, during a compound attack, he allows his opponent to **find the blade**, and continues the attack while his opponent ripostes immediately.
- d) If, during a compound attack, he **bends his arm** or makes a **momentary pause**, during which time the opponent makes a stop hit or an attack while the attacker continues his own attack.
- e) If, during a compound attack, he is **stop-hit** one period of fencing time (temps d'escrime) before he makes his final movement.
- f) If he makes a hit by a remise, redoublement or reprise following a **parry by his opponent** which has been followed by a riposte which is immediate, simple and executed in one period of fencing time without withdrawing the arm.

5. When there is a double hit (coup double), and if the Referee is unable clearly to judge from which side the fault has come, he must replace the competitors on guard.

One of the most difficult cases to judge arises when a stop hit is made and there is doubt as to whether it was made sufficiently in time in relation to the final movement of a compound attack. Generally, in such cases, the double hit occurs through the fault of both fencers concerned, which justifies the Referee replacing them on guard. (The fault of the attacker consists of indecision, slowness of execution or the making of feints which are not sufficiently effective. The fault of the defender lies in delay or slowness in making the stop hit.)

*PART 5. DISCIPLINARY RULES
FOR COMPETITIONS*²

CHAPTER 1. APPLICATION

Persons subject to these rules

- t.81.** 1. The regulations laid down in this Part apply to **all persons** who take part in, or who are present in any capacity whatsoever at an international fencing competition (organisers, officials, referees, fencers, auxiliary personnel, team captains, trainers, spectators, etc.), whatever their nationality.
2. Hereinafter, all these persons are described as ‘**fencers**’.

Maintenance of order and discipline

- t.82.** 1. Fencers must **observe strictly and faithfully** the Rules and the Statutes of the FIE, the particular rules for the competition in which they are engaged, the traditional customs of courtesy and integrity and the instructions of the officials.
2. In particular they will subscribe, in an **orderly, disciplined and sporting manner**, to the following provisions; all breaches of these rules may entail punishments by the competent disciplinary authorities after, or even without, prior warning, according to the facts and circumstances (cf. t.113–t.120).
3. Everybody taking part in or present at a fencing competition must **remain orderly and must not disturb the smooth running** of the competition. During bouts no one is allowed to **go near the pistes**, to **give advice to the fencers**, to **criticise the Referee** or the judges, to insult them or to attempt to influence them in any way. Even the **team captain** must remain in the space assigned to him and he may only intervene in the situations and in the manner provided for in Article t.90 of the Rules. The Referee must stop immediately any activity which disturbs the smooth running of the bout which he is refereeing (cf. t.96.1–3).
4. **Smoking** in competition halls is forbidden. Smoking will be considered as a disturbance of the smooth running of the competition (cf. t.83).

Any breach of these rules will be punished as laid down in Articles t.114, t.118, t.120.

- t.83.** The Referee and/or the Directoire Technique, on their own authority or at the request of an official delegate of the FIE or of the Organising Committee, can decide to **expel from the competition venue**, with or without a warning, any person who by his gestures, attitude or language disturbs the good order or smooth running of the event.

2. The penalties relating to the Publicity Code appear in that appendix.

The competitors

Pledge of honour

- t.84. By the mere fact of entering a fencing competition, the fencers **pledge their honour** to observe the Rules and the decisions of the officials, to be respectful towards the referees and judges and scrupulously to obey the orders and injunctions of the Referee (cf. t.114, t.116, t.120).

Refusing to fence an opponent

- t.85. 1. No fencer (individual or team) from an FIE member national federation may take part in an official competition if he **refuses to fence** against any other fencer whatsoever (individual or team) correctly entered in the event. Should this rule be broken, the competitor concerned, individual or team, shall immediately be disqualified.
2. **The FIE** shall consider whether there are grounds, and to what extent, for taking sanctions against the national federation to which the disqualified competitor belongs (cf. FIE Statutes 1.2.4 and Rules Article t.120).

Presence on time

- t.86. 1. The fencers, completely equipped, with all equipment conforming with the regulations (cf. t.43–t.45) and ready to fence, must **be present at the time and place** appointed for the beginning of the pool, match, or bout of direct elimination, or at the time appointed for the checking of their equipment before their bout (cf. t.43.1–3), as well as during the competition, whenever the Referee requires it.
2. When presenting themselves to fence a bout, the fencers must arrive on the piste **completely ready to fence** — regulation clothing, jacket fastened, sword-hand gloved and holding the weapon, bodywire connected to the plug inside the guard. The mask should be carried in the unarmed hand.

Before the start of the bout, the fencers' hair must be fastened and placed inside the clothing and/or mask in such a way as to ensure that:

- it does not cover a valid surface (and thus prevent a hit from being scored).
- it does not conceal the name and nationality of the fencer.
- it does not need to be put back in place during the bout, thus interrupting it.

In the case of violation of this rule, the referee will apply the penalties for group 1 offences (t.114, t.116, t.120).

3. Under no circumstances should the fencers **dress or undress in public** except in the case of an accident duly recognised by the doctor on duty or by the representative of the Medical Commission (cf. t.87.8, t.114, t.116, t.120).
4. They must arrive on the piste, to fence their bouts, with **two weapons** (one as a spare) and **two bodywires** (one as a spare) which

satisfy the regulations and are in perfect working order(cf. t.45.1, t.114, t.116, t.120).

5. Before the start of the pool, the team match or the bouts of direct elimination (individual or team):

- i) When a fencer or complete team **do not present themselves** to the Referee **at his first call**, ten minutes before the time indicated to come onto the piste for the start of the pool or team match, or the start of the bouts of direct elimination (cf. Article t.43.2), the fencer or team concerned will be **eliminated**.

- ii) A **team** is considered complete when at least three fencers are present.
 - iii) In a team match only those members of the team (the fencers, the team captain and one trainer — cf. Article t.92.4) who are **present at the Referee's first call**, ten minutes before the time indicated for the start of the match, may take part in the match.
6. **In the course of the competition, individual or team**, when a fencer **does not present himself** on the piste, ready to fence, when ordered to do so by the Referee:
- The fencer or team member not present will be penalised with a **Yellow Card**;
 - A second call will be made, one minute after the first call, followed by a **Red Card** for the fencer or team member not present;
 - A third and last call will be made, one minute after the second call, followed by **elimination from the competition** for the fencer not present in an individual competition or for the whole team in a team competition.
7. Should a fencer **abandon a bout** by leaving the piste (cf. t.18.6), he will be penalised as specified in Articles t.114, t.116, t.120.

Fencing etiquette

- t.87. 1. The competitors must fence **faithfully** and strictly **according to the rules** laid down in these Rules. All breaches of these rules will incur the penalties laid down hereinafter (cf. t.114–t.120).
2. All bouts must preserve the **character of a courteous and frank encounter**. All **irregular actions** (flèche attack which finishes with a collision jostling the opponent, disorderly fencing, irregular movements on the piste, hits achieved with violence, hits made while falling) are strictly forbidden (cf. t.114–t.120). Should such an offence occur, any hit scored by the fencer at fault is annulled.
3. Before the beginning of each bout, the two fencers must perform a **fencing salute** to their opponent, to the Referee and to the spectators. Equally, when the final hit has been scored, the bout has not ended until the two fencers have saluted each other, the Referee and the spectators: to this end, they must remain still while the Referee is making his decision; when he has given his decision, they must again perform a fencing salute and must shake hands with their opponent, with the unarmed hand. If either or both of the two fencers refuse to comply with these rules, the Referee will suspend him/them for the remainder of the competition taking place and from the following two FIE competitions in the weapon concerned (cf. t.114, t.119, t.120). The points or titles obtained at the moment of the offence remain acquired.

4. Non-combativity

When both fencers make clear their unwillingness to fight, the Referee will immediately call 'Halt!'

5. Individual events

- a) If during the two first periods of a direct elimination bout both fencers make clear their unwillingness to fight*, the Referee will award a warning (yellow card) against each of the two fencers and will proceed to the next period, without the minute rest.
- b) **If the offence is repeated**, the Referee will each time award a penalty hit (red card) against each of the two fencers and will proceed to the next period, without the minute rest.
- c) When both fencers make clear their unwillingness to fight* during the **third period** of a direct elimination bout:-
 - i) if there has been no occurrence of the offence during the preceding periods, the Referee will award a warning (yellow card) against each fencer, and will proceed to a last minute of fencing;
 - ii) if the offence has already been committed during the course of the preceding periods, the Referee will award a penalty hit (red card) against each of the fencers, and will proceed to a last minute of fencing;

This last minute, which will be fenced in its entirety, will be decisive and will be preceded by a drawing of lots to decide the winner should the scores be equal at the end of the minute.

6. Team events

- a) If both teams make clear their **unwillingness to fight*** during a team match, the Referee will award a warning (yellow card) against each of the two teams and will proceed to the next bout.
- b) **If the offence is repeated**, the Referee will each time award a penalty hit (red card) against each of the teams and will proceed to the next bout, and so on up to the last bout.
- c) If both teams make clear their unwillingness to fight* during **the last bout**:-
 - i) if there has been no occurrence of the offence during the preceding bouts, the Referee will award a warning (yellow card) against each of the teams, and will proceed to a last minute of fencing;
 - ii) if the offence has already been committed during the preceding bouts, the Referee will award a penalty hit (red card) against each of the teams, and will proceed to a last minute of fencing;

* *Clear unwillingness to fight (non-combativity)*

If two of the criteria below are combined, there is unwillingness to fight:

1. criterion of time : one minute of fencing without a hit
2. absence of blade contact
3. excessive distance (greater than the distance of a step-forward-lunge).

This last minute, which will be fenced in its entirety, will be decisive and will be preceded by a drawing of lots to decide the winner should the scores be equal at the end of the minute.

7. The fencer, whether on or off the piste, must **keep his mask on** until the Referee calls 'Halt!' He may under no circumstances address the Referee until the Referee has made his decision (cf. t.114, t.116, t.120).
8. Under no circumstances may fencers **remove their clothes** on the piste, even to change their bodywire (cf. t.114, t.116, t.120).
9. At the end of a bout, the Referee must bring together the two fencers, **to announce clearly the score**, which will be transmitted to the Directoire Technique. He must say clearly: 'Mister X won against Mister Y with the following score ...'

Personal effort

- t.88. Competitors must **fence to their utmost ability** in a sportsmanlike manner until the end of the competition in order to obtain the best possible classification, without giving away hits or seeking to be favoured by being given hits by anyone (cf. t.114, t.119, t.120).

The team manager

- t.89. In all competitions, all competitors of the same nationality must be under the direction of a **team manager** (who may or may not fence), who is responsible to the Directoire Technique or the Organising Committee for the discipline, conduct, and sportsmanship of the members of his team.

The team captain

- t.90. 1. In team events, only the **team captain** has the right to be placed with his fencers in the Piste Enclosure and to approach the President of the Directoire Technique, etc., in order to decide technical matters, or to register protests.
2. The members of the team who have **scrupulously abided by his decisions** may not be held responsible by the relevant authorities. However, they are **personally responsible** for any actions they commit for which their team captain has not taken authority and for any offence committed by them in violation of the present Rules.

The referees and judges

- t.91. The members of the jury must fulfil their duties not only with **total impartiality** but also with the **utmost attention** (cf. t.34.1).

The instructors, trainers and technicians

- t.92. 1. The **instructors, trainers and technicians** are not allowed to remain near their fencers in the Piste Enclosure during the competition.

2. The Referee may, whenever he considers it necessary, authorise a person to **come briefly to the assistance** of a fencer.
3. Each nation which has a fencer taking part in the round of the competition in progress may designate a maximum of **two people** who have the right to be positioned near the Piste Enclosure, outside it but close to a point of access. The organisers must provide the necessary space for these people.
4. In team competitions, there must be enclosures reserved for the team members. Only the team captain and one coach have the right to be with the team fencers **inside the Team Enclosures**, which must be clearly marked out by yellow lines on the ground or some other method. They should be at least 9 m² in area and be located at a distance of between 2 m and 6 m from each end of and outside the Piste Enclosure, which is 18 m ∞ 8 m.
5. During team matches, the team members not actually fencing must **remain within** their Team Enclosure.
6. During team competitions, no one has the right to **enter the Piste Enclosure** without the Referee's permission. In the case of such an offence, the Referee will penalise the offending team as provided for in Articles t.114, t.116 and t.120. A warning imposed on a team is valid for the complete team match. Should a fencer, within the same match, commit another offence from the First Group, the Referee will penalise him on each occasion with a Red Card.

The spectators

- t.93.** Spectators are obliged not to **interfere with the good order** of a competition, to do nothing which may tend to influence the fencers or the Referee, and to respect the decisions of the latter even when they do not agree with them. They must obey any instructions which the Referee may deem it necessary to give them (cf. t.82.3/4, t.118, t.120).

CHAPTER 2. THE DISCIPLINARY AUTHORITIES AND THEIR COMPETENCE

The following articles only regulate discipline at competition venues. Depending on the gravity of the offences established, they do not exclude the application of the Disciplinary Code of the FIE (Chapter VII of the Statutes of the FIE) which completes or, if the case arises, takes priority over the following articles.

Jurisdiction

- t.94.** The following are the **competent disciplinary authorities**:
- the Referee (cf. t.96);
 - the Directoire Technique (cf. t.97, o.56–o.62);
 - the Refereeing Commission delegate(s), or the Supervisor if there is no delegate;

- the Executive Committee of the IOC at the Olympic Games (cf. t.98);
- the Bureau of the FIE (cf. t.99.1/4, t.127.h, o.63);
- the Executive Committee of the FIE (cf. t.99.5);
- the Disciplinary Commission of the FIE and its Tribunal;
- the Court of Arbitration for Sport and the Sports Arbitration Tribunal.

See also Disciplinary Rules of the FIE (Chapter VII of the FIE Statutes).

Principle of jurisdiction

- t.95.**
- 1.** Whatever juridical authority has taken a decision, this decision may be subject to an **appeal** to a higher juridical authority, but only to one such appeal.
 - 2.** No decision on a question of **fact** can be the subject of an appeal (cf. t.122.1/2).
 - 3.** An appeal against a decision only **suspends** that decision when it can be judged immediately.
 - 4.** Every appeal must be accompanied by the **deposit of a guaranty** of US\$80, or its equivalent in another currency; this sum may be confiscated for the benefit of the FIE if the appeal is rejected on the grounds that it is 'frivolous'; this decision will be taken by the juridical authority responsible for hearing the appeal. However, appeals against the decisions of the Referee do not require the deposit of the guarantees mentioned above (cf. t.122).

The Referee

- t.96.**
- 1.** The Referee is responsible not only for the direction of the bout, the judging of hits and the checking of equipment, but equally for the **maintenance of order** in the bouts which he is refereeing (cf. t.35.2.i).
 - 2.** In his capacity as director of the bout and arbiter of hits, he can, in accordance with the rules, **penalise** the competitors, either by refusing to award a hit which they have in fact made on the opponent, or by awarding against them a hit which they have not in fact received, or by excluding them from the competition which he is refereeing, all, according to the circumstances, with or without prior warning. In these circumstances, and if he has judged on a matter of **fact**, his decisions are irrevocable (cf. t.122.1/2).
 - 3.** By reason of the right of jurisdiction which he has over all the fencers who participate in, or are present at a competition which he is refereeing, he can also **propose** to the Directoire Technique the **expulsion** from the venue of the competition of the spectators, trainers, instructors and other persons who accompany the competitors (cf. t.114, t.118, t.120).

4. Finally, he may **recommend** to the Directoire Technique all other penalties which he considers appropriate (exclusion from the whole competition, suspension or disqualification) (cf. t.97.3).
5. The Refereeing Commission delegate or the Supervisor (if there is no delegate) is the **authority competent to deal with appeals** against the decisions of the Referee.

The Directoire Technique at official FIE competitions

(cf. o.56–o.62)

- t.97.**
1. The **Directoire Technique** has jurisdiction over all the fencers who take part in or are present at a competition which it is running.
 2. When necessary it can **intervene on its own initiative** in all disputes.
 3. It is also **responsible for maintaining order** and discipline during competitions, and may use the penalties specified in the Rules.
 4. It **sends** direct to the Central Office of **the FIE** announcements of disciplinary penalties pronounced during the competitions, as well as any requests for censure, suspension, extension of penalty or permanent suspension, and requests for ultimate appeals.
 5. The Directoire Technique **activates** any penalty imposed against which no appeal is possible or which is not subject to suspension (cf. t.95).
 6. The decisions of the Directoire Technique that it takes spontaneously or in its own right (as the first level of authority) are **subject to appeal** to the Disciplinary Commission of the FIE.
 7. All the decisions of the Directoire Technique are **immediately enforceable**. No appeal against a decision can suspend that decision during the competition.

The Executive Committee of the IOC at the Olympic Games

- t.98.** **The Executive Committee of the International Olympic Committee (IOC)** is the final arbiter for all disputes of a non-technical nature which may arise during the Olympic Games. It may intervene either on its own responsibility, or at the request of a national Olympic Committee, the FIE or the Organising Committee.

FIE Central Office, Disciplinary Commission, Executive Committee, Sports Arbitration Tribunal

- t.99.**
1. All disciplinary matters referred to the FIE by a national federation, a Directoire Technique or any other competent body on the occasion of an official FIE competition are addressed to the **Central Office of the FIE**. This latter transmits them to the competent body.
 2. **The Disciplinary Commission of the FIE** is the juridical body of the FIE that, within the limits of the territories over which the FIE has authority, settles all disciplinary matters referred to the FIE and judges all appeals against decisions taken by a Directoire Technique,

the Refereeing Commission delegate or the Supervisor (if there is no delegate).

3. **The Sports Arbitration Tribunal in Lausanne (TAS)** judges all appeals against the decisions of the tribunals of the Disciplinary Commission.
4. In urgent cases, **the FIE Central Office** may take the administrative measures necessary for the suspension of the licence of the accused in accordance with the Disciplinary Code.
5. **The Executive Committee** ensures that the decisions of the Disciplinary Commission are respected and carried out.

See the Disciplinary Code of the FIE (Chapter VII of the FIE Statutes).

CHAPTER 3. PENALTIES

Classification of penalties

t.100. There are distinct **categories** of penalty applicable to different sorts of offence (cf. t.114ss).

1. **Penalties related to fencing**, applicable to offences committed while fencing. These are:

- the loss of ground on the piste
- refusal to award a hit actually made
- awarding a hit which has not in fact been received
- exclusion from the competition

2. **Disciplinary penalties** applicable to offences concerned with maintenance of order, discipline or sportsmanship. These are:

- awarding a hit which has not in fact been received
- exclusion from the competition
- exclusion from participation in the whole tournament
- expulsion from the venue of the competition
- disqualification
- censure
- fine
- temporary suspension
- permanent suspension

t.101. 1. All these penalties except permanent suspension **can be applied** by the competent authorities at a competition — the Referee and the Directoire Technique.

2. **Temporary suspension** can be applied by these authorities only in the case of a fencer refusing to salute (cf. t.87.3, t.120).

See the Disciplinary Code of the FIE (Chapter VII of the FIE Statutes).

Penalties related to fencing

Loss of ground on the piste (cf. t.28.1)

- t.102.** A competitor who **crosses the lateral boundaries** of the piste with one or both feet is penalised by the loss of one metre of ground.

Refusal to award a hit actually made

- t.103.** Although a competitor may in fact have hit his opponent on the target, **this hit may be disallowed**, either because it did not arrive during the period of time during which fencing is allowed, or because the competitor had crossed the boundaries of the piste, or because of defects in the electrical equipment, or because violence was involved in the making of the hit, or because of other reasons as laid down in the Rules (cf. t.18.1/3, t.20.2/3, t.21.2/4, t.22, t.26.2/4, t.32.2, t.41.2, t.45.3, t.53.3, t.60.2/6, t.66.1, t.67, t.68, t.70.3, t.73.1–4, t.80, t.87.2, t.96.2, t.114.2, t.120).

Award of a hit which has not in fact been received

- t.104.** A competitor may have a **hit awarded against him** which he has not in fact received, either because he has crossed the rear limit of the piste (cf. t.27), or because he has committed an offence which has prevented his opponent fencing (a flèche attack which jostles the opponent, a corps à corps at foil or sabre, the use of the unarmed hand while fencing, etc.) (cf. t.96.2, t.114.3.a/b, t.116, t.117, t.118.1, t.120).

Exclusion

- t.105. 1.** A competitor who, while fencing, commits certain **violent or vindictive actions** against his opponent, or who does not **fence to his utmost ability**, or who **profits from a fraudulent agreement** with his opponent, may be excluded from the competition.
- 2.** A **competitor who is excluded** from a competition may not continue to take part in that competition, even if he is already qualified for promotion to the next round. He loses the right to his individual classification and all the fencers ranked after the disqualified fencer move up one place in the results of the competition. If necessary the two third places are decided according to their ranking for the composition of the table. Under all circumstances, only fencers who have actually received points in the competition can move up a place in the competition's results.

Disciplinary penalties

Exclusion from the competition

- t.106. 1.** **Exclusion from a competition** may also be imposed for a disciplinary offence (failure to appear on the piste as required, weapons not in accordance with the rules, reprehensible attitude towards a judge, etc.).

2. The consequences of such exclusion for the competitor are the same as those described in Article t.105 above.

Exclusion from participation in the whole tournament

- t.107. **1. Tournament** is the name given to a number of competitions, individual and team, held at the same place, at the same period and under the same aegis.
2. A competitor who is excluded from a tournament will no longer be allowed to participate **in any competition** during that tournament, either at the same weapon or another.
3. When this penalty is imposed **on a team**, the position of each member of that team must be examined individually, and the members of that team may, according to the circumstances, have different penalties imposed on them (cf. t.90.2).

Expulsion from the venue of the competition or the tournament

- t.108. All participants or non-competitors who participate in or are present at a competition (instructors, trainers, technicians, supporters, officials, spectators) **may be expelled**. Such expulsion has the effect of forbidding them access to the venue for the duration of the competition or tournament (cf. t.93, t.106.3, t.120). In no circumstances can the imposition of this penalty give cause for redress to anyone.

Disqualification

- t.109. **1. Disqualification** of a competitor (for example, because he does not conform to the rules regarding age, qualification, etc. required for the competition) does not necessarily incur his (temporary) suspension or permanent suspension, if he has acted in good faith; a request for supplementary penalties for fraudulent intention may, however, be made against the competitor.
2. A team **which has included a competitor who is disqualified** necessarily incurs the penalty of that member and is also disqualified.
3. The consequences of disqualification are the same as those for exclusion from the competition (see Article t.105 above).

Censure

- t.110. In cases where a more severe disciplinary sanction is not justified, the fencer or the official may be sanctioned by **censure**.

Temporary suspension

- t.111. **1. A competitor who is suspended** cannot take part in any official FIE competition during the time he is suspended.
2. **All other persons who are suspended** are debarred from exercising their functions within the limits of time and place fixed when the suspension is imposed.

Permanent suspension

t.112. Permanent suspension involves the same consequences as suspension, but is permanent.

Announcement of penalties

- t.113. 1.** The Directoire Technique is required to **inform** the Central Office of the FIE without delay of **penalties** applied during the competition and their reasons (cf. t.97.5).
- 2. At the Olympic Games**, the Directoire Technique must advise the IOC via the Organising Committee.

CHAPTER 4. THE PENALTIES AND THE COMPETENT JURIDICAL AUTHORITIES

The types (groups) of penalty

- t.114. 1.** There are **three types of penalty** to be applied in the cases indicated in the table in Article t.120. If a referee has to penalise a fencer who has committed several faults at the same time, he should penalise the least serious fault first.
- 2.** Penalties are **cumulative and they are valid for the bout** with the exception of those indicated by a BLACK CARD, which means exclusion from the competition, suspension for the remainder of the tournament and for the following two months of the active season (1 October – World Championships for the Juniors, and 1 January – World Championships for the Seniors), whether current or forthcoming.

However, a **team** excluded from a tournament because of a BLACK CARD imposed on one of its members is not excluded as a team from the following competitions, but it may not select the penalised fencer.

Certain offences can result in the **annulment of the hit** scored by the fencer at fault. During the bout, only hits scored in circumstances connected with the offence may be annulled (cf. t.120).

- 3. The penalties** are as follows:
- a) a warning**, indicated by a YELLOW CARD with which the Referee identifies the fencer at fault. The fencer then knows that any further offence on his part will result in a penalty hit.
 - b) a penalty hit**, demonstrated by a RED CARD with which the Referee identifies the fencer at fault. A hit is added to the score of his opponent and may, if the last hit is at stake, lead to the loss of the bout. Furthermore, a RED CARD can only be followed by another RED CARD or by a BLACK CARD, depending on the nature of the second offence (cf. t.120).
 - c) Exclusion** from the competition, suspension from the remainder of the tournament and for the following two months of the active

season, whether current or forthcoming, or expulsion from the competition venue (any person disturbing the order of the competition), demonstrated by a BLACK CARD by which the Referee identifies the person at fault.

4. All warnings (YELLOW CARDS), penalty hits (RED CARDS) and exclusions (BLACK CARDS) must be **noted on the score-sheet** of the bout, the pool or the match, together with the group to which they belong.

Competence

- t.115. The **offences and their penalties** which appear in different articles of the Rules are summarised in the list that follows in Article t.120; they are divided into four groups (cf. t.116–t.119). All these penalties are within the **competence of the Referee**, although the Directoire Technique still retains the right to intervene on its own initiative (cf. t.97.1–3).

The First Group of offences

- t.116. The first infringement, in this First Group, is penalised by a YELLOW CARD (warning). If during the same bout the fencer commits the same or a different offence in this group, the Referee penalises him, on each occasion, with a RED CARD (penalty hit). If the fencer at fault has already been penalised by a RED CARD because of an offence listed in the Second or Third Group, he receives a further RED CARD for his first infringement relating to the First Group.

The Second Group of offences

- t.117. Every offence in the Second Group, including the first infringement, is penalised by a RED CARD (penalty hit).

The Third Group of offences

- t.118. 1. The first infringement in the Third Group is penalised by a RED CARD (penalty hit), even if the fencer at fault has already received a RED CARD as a result of offences in the First or Second Groups.
2. If during the same bout the fencer commits the same or a different offence in this group, he is penalised with a BLACK CARD (exclusion from the competition, suspension from the remainder of the tournament and for the following two months of the active season (1 October – World Championships for the Juniors, and 1 January – World Championships for the Seniors), whether current or forthcoming).
3. Any person **not on the piste** who disturbs the good order of the competition receives:
 - a) On the **first infringement**, a warning, indicated by a YELLOW CARD, valid for the whole of the competition, which must be noted on the bout score-sheet and recorded by the Directoire Technique;

Schedule of Offences and Penalties

	OFFENCE	ARTICLE	FIRST OFFENCE	SECOND OFFENCE	THIRD & SUBSEQ.
FIRST GROUP	Leaving piste without permission	t.18.6			
	Simple corps à corps (foil and sabre) *	t.20.2			
	Corps à corps to avoid being hit *	t.20.3, t.62.2			
	Turning back on opponent *	t.21.2			
	Touching/taking hold of electrical equipment *	t.22.3			
	Covering/substitution of valid target *	t.22.2, t.49.1, t.72.2			
	Leaving piste to avoid being hit	t.28.3			
	Interruption of bout without valid reason	t.31.2			
	Placing the weapon on the conductive piste to straighten it	t.46.2/3, t.61.2/3, t.70.6			
	Clothing/equipment not working or not conforming; absence of second regulation weapon or bodywire	t.45.1/2/3.a) ii, t.86.4	YELLOW CARD	RED CARD	RED CARD
	At foil and épée, bending, dragging weapon point on conductive piste	t.46.2/3, t.61.2/3			
	Bringing weapon into contact with conductive jacket *	t.53.3			
	At sabre, hit made with the guard *, any forward movement crossing the legs or feet *	t.70.3, t.75.5			
	Refusal to obey the Referee	t.82.2, t.84			
	Jostling, disorderly fencing, irregular movements on the piste, hits made with violence or while falling *	t.86.3, t.87.2			
	Taking off mask before the Referee calls 'Halt!'; undressing on the piste	t.87.7/8			
	Unjustified appeal	t.122.2/4			
	Non-Combativity	t.87.4/5/6			
SECOND GROUP	Use of non-sword arm/hand *	t.22.1			
	Interruption of bout for claimed injury not confirmed by doctor	t.33.3			
	Absence of weapon check marks *	t.45.3.a)	RED CARD	RED CARD	RED CARD
	Deliberate hit not on opponent	t.53.2, t.66.2			
	Absence of name on back, absence of national colours when compulsory, at Individual World Cup competitions and (from 2006–07 season) Zonal Championships	t.45.4			
	Dangerous, violent or vindictive action, blow with guard or pommel * ...	t.87.2, t.103, t.105.1			

Table continues overleaf

* Annulment of any hit scored by the fencer at fault.

Schedule of Offences and Penalties (contd.)

	OFFENCE	ARTICLE	FIRST OFFENCE	SECOND OFFENCE	THIRD OFFENCE
THIRD GROUP	Faking weapon check marks, intentional modification of equipment * t.45.3.a) iii, iv		RED CARD	BLACK CARD	
	Fencer disturbing order when on piste (2) t.82.3, t.83, t.96.2				
	Dishonest fencing * t.87.1				
	Offence against Publicity Code Publicity Code				
	Any person not on piste disturbing good order t.82.3/4, t.83, t.96.3, t.118.3		YELLOW CARD VALID FOR WHOLE COMP'N, OR (2)	EXPULSION (1 or 2)	
	Non-presentation on the piste during the competition when ordered by the Referee, with three calls at one-minute intervals t.86.6		AT FIRST CALL YELLOW CARD	AT SECOND CALL RED CARD	AT THIRD CALL ELIMINATION FROM COMP'N
	Non-presentation when first called by Referee, ten minutes before time indicated for start of pool/team match/bouts of direct elimination t.86.5		ELIMINATION FROM COMPETITION		
	Absence of name on back, absence of national colours when compulsory, at World Championships/ Team World Cup competitions t.45.4				
	Refusal of fencer to salute his opponent before beginning or at end of bout t.87.3		SUSPENSION (3)		
	Refusal of a fencer to fence another competitor (individual or team) properly entered t.85.1		DISQUALIFICATION		
FOURTH GROUP	Manifest cheating with equipment t.45.3.a) v		BLACK CARD		
	Fencer equipped with electronic communication equipment permitting him to receive communications during the bout t.43.1.f, t.44.2, t.45.3.a) vi				
	Offence against sportsmanship t.87.2, t.105.1				
	Deliberate brutality * t.105.1				
	Profiting from collusion, favouring an opponent t.88, t.105.1				
	Doping t.127				

YELLOW CARD = Warning (valid for bout, whether one or several encounters). If a fencer commits an offence in the First Group after having been penalised with a RED CARD, for whatever reason, he receives a further RED CARD.

RED CARD = Penalty hit.

BLACK CARD = Exclusion from the competition, suspension from the remainder of the tournament and for the following two months of the active season (1 October – World Championships for the Juniors, and 1 January – World Championships for the Seniors), whether current or forthcoming. A fencer only receives a BLACK CARD in the Third Group if he previously committed an offence in this Third Group (demonstrated by a RED CARD).

(1) Expulsion from competition venue. (2) In serious cases, Referee may exclude/expel immediately. (3) Suspension for the remainder of the competition taking place and from the following two FIE competitions in the weapon concerned. The points or titles obtained at the moment of the offence remain acquired.

fied, the fencer will be penalised in accordance with Articles t.114, t.116, t.120.

Other protests and appeals

- t.123.** 1. Complaints and protests must be made **in writing without delay**; they must be addressed to the Directoire Technique.
2. Protests over the **composition of the first round** at World Championships and the Olympic Games may only be made up to 7 p.m. of the day before the event (cf. o.10).

Investigation — Right of defence

- t.124.** No penalty can be imposed until after an **enquiry** has been held in the course of which the parties concerned have been called on to give their explanation of the occurrence either verbally or in writing, within a reasonable interval of time, suited to the time and place. After this time limit has expired, the penalty may be imposed.

Method of decision

- t.125.** The decisions of the juridical authorities of competitions are by **majority vote**, the chairman (president) having the casting vote in case of a tie.

Repetition of offence

- t.126.** 1. For offences regarding sportsmanship, good order or discipline, a fencer is said to **repeat** an offence if he commits a new offence, other than violation of the rules governing bouts, within two years of being censured, or subjected to exclusion, disqualification or suspension.
2. For the repetition of an offence, the **penalty** which must be imposed is:
- a) **Exclusion** from the competition, if the previous penalty was a censure.
 - b) **Disqualification** from participation in the whole tournament, if the previous penalty was exclusion or disqualification from a competition.

See also the Disciplinary Code of the FIE (Chapter VII, FIE Statutes-).

CHAPTER 6. ANTI-DOPING CONTROLS

- t.127.** a) **Doping** is forbidden by the FIE. Any breaking of this rule will incur disciplinary action.
- b) Doping is defined as the occurrence of one or more of the anti-doping rule violations set forth in **Articles 2.1 through 2.8 of the FIE Anti-Doping Rules**.
- c) The FIE has committed itself to the **WADA Anti-Doping Code**. The FIE Anti-Doping Rules are based on the WADA 'Models of Best Practice' and adopt in their entirety the 'mandatory clauses' of the above document. The FIE also adopts in full the WADA 'Prohibited Classes of Substances and Prohibited Methods' document.

- d) The FIE reserves the right to conduct doping control **during competitions** — that is, at any competition organised under its control — as well as **out-of-competition**.
- e) The athletes who participate in FIE competitions undertake to respect the FIE anti-doping Rules, use neither prohibited substances nor prohibited methods and agree to submit to any anti-doping control, whether in- or out-of competition;
- f) **All the details** concerning the doping controls at official FIE competitions, as well as out-of-competition, are to be found in the articles of the Anti-Doping Rules of the FIE.
- g) The **penalties** and consequences of the penalties arising from violations of the anti-doping rules are those laid down in the Anti-Doping Rules of the FIE.
- h) Fencers found to have contravened these anti-doping rules will be subject to the **procedures provided for in the Anti-Doping Rules**. The publication of test results and decisions relating to application of penalties will be announced by the Central Office of the FIE, which alone has the right to bring them to the notice of all member federations.
- i) Doping offences committed and penalised in one of the **member countries** of the FIE will be taken into account and the penalties ('sanctions') will be applied by all member countries of the FIE.
- j) **Modification of the FIE Anti-Doping Rules** falls within the competence of the Executive Committee.

INDEX TO ARTICLES

Numbers refer to articles of the Rules.

- Abandon: see «Withdrawal»
Abnormal movement: t.22, t.72
Absence of check marks on
material: t.45, t.120
Accident: t.33, t.86
Accidental cause: t.29, t.54, t.68, t.73
Accompany, persons who: t.96
Action: t.6ss, t.16, t.56
Action (simultaneous): t.60, t.80
Action (vindictive, violent): t.63, t.87,
t.103, t.105, t.120
Active season: t.87, t.114, t.118ss
Advice (giving): t.82
A Grade competitions: see «World
Cup»
Analysis of the fencing phrase: t.42
Announcement (penalties): t.113
Annulment of hit: see «Hits
(annulment)»
Anti-doping: t.120, t.127; see also
FIE Anti-Doping Rules
Apparatus: t.32, t.35s, t.40s, t.50ss,
t.64ss, t.73
Apparatus (audible): see «Audible
signal»
Appeals (against a decision): t.95ss,
t.122s
Appeals (against composition of
first round): t.123
Appeals (deadlines): t.87, t.122,
t.123
Appeals (formulated by): t.90, t.122
Appeals (unjustified): t.120, t.122
Arm (extending, straight): t.7, t.10
Arm (non-sword): t.22, t.120
Assault: t.2
Attachment (on handle): t.16
Attack: t.7s, t.56ss, t.75ss
Attribution of Directoire Technique:
see «Directoire Technique»
Attribution of referees: see
«Referee (attribution)»
Audible signal: t.32
Avoid a hit: t.20, t.28, t.63, t.120
Awarding of hit not recorded: t.100,
t.104, t.120
Back: see «Surface», «Turn back on
opponent»
Back of blade: t.70
Bend of blade: see «Curve in blade»
Black Card: t.114, t.118ss
Blade: t.70
Blade (areas of insulation): t.68
Blade (broken): t.54, t.68, t.73
Blade ('foible' and 'forte'): t.78
Blade (mere contact of): t.56, t.60,
t.76, t.80
Blocking the scoring apparatus: t.32,
t.53
Bodywire: t.43, t.45, t.68, t.86s,
t.120
Bout: t.2
Bout (beginning, stopping, restarting):
t.18
Bout (score-sheet): t.87
Bout (duration): see «End of bout»
Bout (end): see «End of bout»,
«Number of hits»
Bout (number of hits): see «End of
bout», «Number of hits»
Bout Committee: see «Directoire
Technique»
Broken blade: t.54, t.68, t.73
Brutality: t.63, t.87, t.120
Bureau of the FIE (Central Office of
the FIE): t.94, t.99
Cadets: t.1
Calling (fencers — initial, onto piste):
t.17, t.35, t.86, t.120
Card (Yellow, Red, Black): see
«Penalties», «Yellow Card»,
«Red Card», «Black Card»
Category A (competitions):
see «World Cup»
Censure: t.100, t.110, t.126,
t.94, t.99

Central Office of the FIE (Bureau):
Championship: t.5
Change (of ends — judges): t.36
Change (of hand, weapon): t.16
Checking (equipment): t.35, t.43ss
Circulation around pistes: t.90, t.92
Classification: t.105
Clock: t.30, t.32
Close quarters: t.19
Clothing: t.15, t.35, t.43ss, t.120
Collision: t.87
Collusion: t.88, t.105, t.120
Coming on guard: t.14, t.17, t.24s, t.28
Commands (Referee): see «Referee
(signals and commands)»
Communication equipment
(electronic): t.43ss, t.120
Competitions: t.1, t.4
Competitions (A Grade): see
«World Cup»
Compound (actions): t.8, t.56,
t.58ss, t.75, t.77, t.80
Conductive piste: t.54, t.67ss
Confiscating defective equipment:
t.45
Confused fencing: t.18, t.54, t.73
Contact, electrical: t.53, t.120
Control (doping): t.94, t.127; see
also FIE Anti-Doping Rules
Control by Referee: t.96
Control (fencers' equipment):
see «Checking (equipment)»
Conventional weapons: t.42
Conventions (foil): t.46ss
Conventions (épée): t.61ss
Conventions (sabre): t.70ss
Corps à corps: t.20, t.24s, t.63, t.104,
t.120
Counter-attack: t.8
Counter-riposte: t.7
Counter-time: t.8
Coup double: t.60, t.64, t.67, t.80
Coupé: see «Cutover»
Coup lancé: t.18, t.26, t.32
Court of arbitration for sport: t.94
Courtesy: t.82, t.87, t.122
Covering the valid target: t.22s, t.72,
t.120; see also «Surface»
Criticising referees/judges: t.82
Crossing legs (sabre): t.56, t.75, t.120
Crossing limits of piste: t.26ss, t.120
Curve in blade: t.45
Cutting edge (hit with the): t.70, t.79
Cutting off the apparatus: t.32
Cutover: t.8, t.56, t.76
Cuts: t.70
Dangerous fencing: t.18, t.87, t.120
Decision (regarding point of fact):
t.95s, t.122
Decision (attempt to influence): t.82,
t.93
Defective equipment: t.45
Defence (right of): t.124
Defend personal chance: see
«Utmost ability (fence to)»
Defensive actions: t.6s, t.9; see also
«Parry»
Delayed (riposte): t.8, t.60, t.80
Delegates — SEMI: see «SEMI
(Committee)»
Delegates — FIE Medical
Committee: t.33, t.86
Delegates — FIE Refereeing
Committee: t.37, t.38
Deposit of guarantee: t.95
Dérochement: t.56, t.60, t.76, t.80
Device (safety): see «Safety device»
Dimensions (piste): see «Piste»
Direction of the bout: t.35, t.96
Directoire Technique: t.23, t.33s,
t.83, t.87, t.96, t.97, t.99, t.101,
t.113, t.115, t.118, t.122s
Disarming: t.18
Disciplinary authorities: t.94ss
Disciplinary procedure: t.121ss
Disciplinary Code of the FIE: t.94,
t.99, t.101, t.126
Disciplinary Commission: t.94, t.97,
t.99
Disciplinary offences: t.101, t.106ss
Discipline: t.82, t.89, t.94, t.100s,
t.120, t.126
Disengagement: t.8, t.56, t.76
Disorderly fencing: t.87
Displacing target: t.21; see also
«Extension (of the valid surface)»

Disqualification: t.85, t.96, t.100, t.105, t.109, t.120, t.126
Disturbing good order: t.82s, t.93, t.118, t.120
Distance (on-guard): t.17
Doctor: t.33, t.86, t.120
Doping: t.120, t.127; see also FIE Anti-Doping Rules
Double hit: t.60, t.64, t.67, t.80
Doubtful (hit): t.54, t.68, t.73
Dragging point on conductive piste: t.46, t.61, t.120
Drawing lots: t.37
Dressing (forbidden on the piste): t.86
Drugs: see «Anti-doping»
Ducking: t.21
Duration of bout: t.30; see also «End of bout»
Duration of contact: see «Contact»

Electronic communication equipment: t.43ss, t.120
Elimination: t.45, t.86, t.120
Enclosure: see «Piste enclosure»
End of bout: t.32
Epée: t.42ss, t.61ss, t.120
Equipment (of fencers): t.15, t.35, t.43ss, t.54, t.68, t.73, t.86
Equipment (failure): see «Failure»
Equipment (non-regulation): t.45, t.120
Etiquette (fencing): t.87
Exclusion (fencer): t.86, t.96, t.100, t.105ss, t.114, t.118ss, t.126
Executive Committee: t.94, t.99
Experts (electrical equipment): t.35, t.43, t.45, t.68, t.73
Expiry of time: t.32; see also «End of bout»
Expulsion: t.83, t.96, t.100, t.108, t.114, t.118, t.120
Extension (of the valid surface): t.49
Extension (of the penalty): t.97

Failure (of clock): t.32
Failure (of electrical material): t.54, t.68, t.73, t.103

Failure (to appear on time): t.86
Falling, hit made while: t.87, t.120
Falsification of equipment: t.45, t.120
Favouring an opponent: t.88, t.120
Feint: t.56, t.58, t.60, t.75ss
Fencers (obligations of): t.84ss
Fencing: t.16ss
Fencing (beginning, stopping, restarting): t.18
Fencing (close quarters): t.19
Fencing (confused): t.18, t.54, t.73
Fencing (dangerous/violent): t.18, t.87, t.120
Fencing etiquette: t.87ss
Fencing (incorrect/unsporting): t.87, t.120
Fencing (respect of phrase): t.56ss, t.75ss
Fencing (time): t.6, t.8, t.59, t.60, t.77, t.80
FIE Supervisor: t.39
Field of play: see «Piste»
Finals (referees, judges): t.36s
Finals (time-keeper): t.30, t.32, t.42
Finals (presentation of fencers for equipment checking): t.43
Fine: t.100
Flèche: t.7, t.21, t.25, t.28, t.56, t.63, t.75, t.87, t.104, t.120
Foil: t.19s, t.22, t.43s, t.46ss, t.104, t.120
Follow the phrase: t.19
Forbidden: t.120
Forbidden substances: see «Doping»
Forbidden (changing hand during the bout): t.16
Forbidden (doping): t.120, t.127
Forbidden (flèche and forward movement crossing legs at sabre): t.75, t.120
Forbidden (give advice): t.82, t.120
Forbidden (hindering tests to detect a fault in the equipment): t.35
Forbidden (hitting with guard): t.70, t.120
Forbidden (irregular actions): t.87, t.120
Forbidden (leave the piste without permission): t.18, t.120

- Forbidden (place non-insulated part of weapon on conductive jacket at foil): t.53, t.120
- Forbidden (protection or substitution of valid target at foil and sabre): t.22, t.120
- Forbidden (pushing or letting drag the point): t.46, t.61, t.120
- Forbidden (smoking in competition halls): t.82, t.120
- Forbidden (straightening weapon on piste): t.46, t.61, t.70, t.120
- Forbidden (turning back on opponent): t.21, t.120
- Forbidden (undressing on the piste): t.87, t.120
- Forbidden (use of non-sword hand and arm): t.22, t.120
- Fortuitous circumstances: t.29, t.54, t.68, t.73
- Frivolous appeal: t.95
- Functions of the Referee: see «Referee»
- Gaining ground: see «Ground gained/lost»
- Grip: t.16
- Ground gained/lost: t.24ss, t.28, t.100, t.102
- Ground judges: see «Judges»
- Guaranty (deposit): t.95
- Guard (hitting with at sabre): t.70, t.120
- Hair: t.86.2**
- Halt: t.18, t.21, t.24, t.26, t.30, t.32, t.46, t.53, t.61, t.63, t.66, t.87, t.120
- Hand (injured/holding weapon): t.16
- Hand (judges): see «Judges»
- Hand (non-sword): see «Use of non-sword hand/arm»
- Handle: t.16
- Hindering tests to detect faults: t.35
- Hits (annulment): t.20ss, t.53ss, t.66ss, t.72ss, t.103, t.114, t.120
- Hits (before 'Play!'): t.18, t.53, t.66, t.73
- Hits (brutal): t.87, t.120
- Hits ('coup lancé'): see «Coup lancé»
- Hits (after crossing the boundaries of the piste): t.26
- Hits (after 'Halt!'): t.18, t.53, t.66, t.73
- Hits (at the end of a bout): t.32
- Hits (double): t.60, t.64, t.68, t.80
- Hits (doubtful): t.54, t.68, t.73
- Hits (flat — sabre): t.70
- Hits (judging): t.34ss, t.40ss, t.50ss, t.64ss, t.73ss, t.96
- Hits (method of making): t.46, t.61, t.70
- Hits (not valid): t.48, t.49, t.53, t.66
- Hits (other than on opponent): t.36, t.53, t.66, t.120
- Hits (penalty): t.114ss; see also «Refusal (to award a hit)»
- Hits (seeking, giving away, offering): t.88, t.120
- Hits (simultaneous): t.60, t.80
- Hits (stop hits): see «Stop hit»
- Hits (through the blade): t.70
- Hits (thrusting with the point): t.46, t.61, t.70
- Hits (with the back of the blade): t.70
- Hits (with the cutting edge): t.70
- Hits (with the guard): t.70
- Immediate (hit): t.26
- Impartiality (referees and judges): t.34, t.91
- In line: see «Point in line»
- Incorrect (fencing): t.87, t.120
- Influence decisions, referees and judges (attempt to): t.82, t.93
- Injury: t.16, t.33
- Insult (referee, judge): t.82
- Integrity: t.82, t.87, t.105, t.120
- International Olympic Committee: see «IOC»
- Interruption of a bout: t.31, t.120
- Intervention of Directoire Technique: t.97, t.115
- Investigation: t.124
- IOC: t.98, t.113, t.129
- Irregular movements: t.87; see also «Violent fencing»
- Irregularities in equipment (deliberate): t.45/3, t.120

- Jacket (conductive): t.44s, t.53, t.120
 Jacket (fencing): t.44
 Jamming the apparatus: t.53
 Jostling: t.87, t.120
 Judges: t.23, t.35, t.36, t.40, t.49, t.82, t.84, t.91
 Judging (hits): t.40ss, t.50ss, t.64ss, t.73ss
 Jurisdiction (principle of): t.95, t.121
- Label of safety/guarantee: t.43
 Lamps: t.35
 Lap: t.30
 Leaving piste: t.18, t.26ss, t.86, t.120;
 see also «Crossing limits of piste»
 Left-hander: t.17
 Length of piste: see «Piste»
 Licence, international: t.127
 Licence, refereeing: t.35
 Limits of piste: see «Piste», «Crossing limits of piste», «Lines on piste»
 Line: see «Point in line»
 Lines on piste: t.13s
 Location (for instructors, trainers, technicians): t.92
 Location (of fencers, judges): t.17, t.23, t.36
 Localisation of a fault in equipment: t.54, t.68, t.73
 Loss of ground: see «Ground gained/lost»
 Lunge: t.7, t.56, t.75
- Manifest cheating with equipment: t.45, t.120
 Mask: t.43s, t.87, t.120
 Match: t.3
 Material; see «Bodywire», «Checking (equipment)», «Mask»
 Materiality of hits: t.40ss, t.51, t.65, t.73
 Medical Commission: «Medical delegate»
 Medical delegate: t.33, t.86
 Method (of fencing): t.87
 Method (of holding weapon): t.16
 Method (of decision): t.125
- Modification to Rules: t.1
 Modification of order of bouts: t.33, t.86, t.120
- Name (on back): t.45, t.120
 Nationality (on back): t.45, t.120
 National strip: t.45, t.120
 Neutrality: see «Referee», «Judges»
 Non-combativity: t.87, t.120
 Non-presentation: t.86, t.120
 Non-regulation equipment: t.45, t.120
 Number of hits: t.30; see also «Hits»
- Obedience: t.82, t.84, t.120
 Obligatory application of Rules: t.1
 Offences: t.115ss; see also «Forbidden»
 Offensive actions: t.7s, t.56
 Official delegate: t.83
 Official competitions of FIE: t.1
 Olympic Games: t.1, t.37s, t.43, t.45, t.98, t.113, t.123
 On guard: t.14, t.17, t.24s, t.28, t.60, t.80
 Order, disturbing good: t.82ss, t.120
 Organising Committee: t.44, t.83, t.89, t.98, t.113
 Orthopaedic (handle): t.16
- Parry: t.7, t.9, t.57, t.79
 Passing opponent: t.21
 Passivity: t.87, t.120
 Penalties: t.96ss, t.100ss, t.114ss, t.121ss
 Penalties (fencing): t.102ss
 Penalties (disciplinary): t.106ss
 Penalties (table of): t.120
 Penalties (types): t.114ss
 Period (direct elimination bout): t.17, t.30, t.36
 Permanent suspension: t.100s, t.112, t.127
 Permission to leave piste: t.18
 Piste: t.11ss, t.26ss, t.54, t.67ss, t.120;
 see also below, and «Crossing limits of piste», «Ground gained/lost»
 Piste Enclosure: t.90, t.92
 Piste (place nearby for instructors,

trainers, technicians): t.92
 Piste (straightening weapon on):
 t.46, t.61, t.70, t.120
 Placing on guard: t.14, t.17
 Plastron (conductive): see «Jacket
 (conductive)»
 Plastron (protective): see «Under-
 plastron»
 Pledge of honour (referees and
 judges): t.34
 Pledge of honour (fencers): t.84
 Plug (bodywire): t.43, t.68; see also
 «Bodywire»
 Plugging in of bodywire: t.43, t.68
 Point in line: t.10, t.17, t.56, t.60, t.76,
 t.80
 Pointe d'arrêt (button): t.44s
 Points: t.105
 Presentation on time: t.86, t.120
 President of jury: see «Referee»
 Priority of hit: t.42, t.52, t.54ss,
 t.74ss
 Procedure for checking the
 equipment by the Referee: t.43ss
 Protection (of the valid target): t.22,
 t.23, t.120
 Protective plastron: t.43, t.45
 Protest (procedure): t.123
 Protests: see «Appeals»
 Punctuality: t.86, t.120
 Pushing point on the piste: t.46, t.61,
 t.120

 Red Card: t.45, t.86, t.92, t.114,
 t.116ss, t.120
 Redoublement: t.8, t.60, t.80
 Referee: t.5, t.30, t.33ss, t.44, t.54s,
 t.65ss, t.73s, t.81ss, t.91ss, t.94ss,
 t.115ss, t.122
 Referee (attribution): t.37s
 Referee (candidate): t.35
 Referee (checking): t.35, t.43ss
 Referee (judging of hits): t.40ss,
 t.51ss, t.65ss, t.73ss, t.96
 Referee (signals and commands):
 t.42 (Figure 3)
 Refereeing delegate: t.94, t.96, t.99,
 t.122
 Refusal (to award a hit): t.18, t.20ss,
 t.26ss, t.32, t.41, t.45s, t.53s,
 t.60, t.66ss, t.70, t.75, t.80, t.87,
 t.100, t.103, t.114, t.120
 Refusal (to fight an opponent): t.85
 Refusal (to obey): t.82, t.84, t.120
 Registration of hits: t.51ss, t.65ss, t.73
 Remise: t.8, t.60, t.80
 Repetition of offence: t.126; see also
 «Penalties»
 Replacing fencer: t.33
 Replacing referee, judge: t.37
 Replacing on guard: t.17, t.21, t.24s,
 t.28, t.54, t.60, t.80
 Reprise of attack: t.8, t.60, t.80
 Respect of the fencing phrase: see
 «Fencing (respect of phrase)»
 Responsibility of fencers: t.15, t.87,
 t.90
 Restarting bout: t.18, t.54, t.68, t.73
 Result: see «Score»
 Retirement: see «Withdrawal»
 Retreat: see «Ground gained/lost»
 Right of defence: t.124
 Right-handed: t.17
 Riposte: t.7s, t.57s, t.60, t.77ss, t.80

 Sabre: t.19, t.20, t.22, t.43, t.70ss,
 t.120
 Salute: t.87
 Safety: t.15
 Safety device: t.68
 Salute (fencer's): t.87, t.120
 Score (sheet): t.87
 Scorers: t.35
 Season, active: t.87, t.114, t.118ss
 Seeking corps à corps: t.20, t.63,
 t.120
 Shake hands: t.87
 SEMI (Committee): t.43, t.45, t.54,
 t.68, t.73
 Simultaneous action: t.60, t.80
 Signals (audible): t.32
 Signals (Referee): see «Referee
 (signals and commands)»
 Signals (visual): see «Lamps»
 Signatures of fencers: t.87
 Simple actions: t.8s, t.56s, t.60, t.75,
 t.79s
 Special device (handle): t.16

Spectators: t.81, t.93, t.96, t.108
 Spool: t.21
 Sports Arbitration Tribunal (TAS):
 t.94, t.99
 Sportsmanship: t.82, t.101, t.120,
 t.126
 Starting bout: t.18, t.87
 Stimulants: see «Anti-doping»
 Stop hit: t.8, t.59, t.60, t.77, t.80
 Stopping bout: see «Interruption of a
 bout»
 Straightening blade on the piste: t.46,
 t.61, t.70, t.120
 Strip: see «Piste»
 Substitution of target: see «Valid
 target»
 Surface (non-valid): t.48s, t.72
 Surface (valid): see «Valid target»
 Suspension (decision/penalty): t.95
 Suspension: t.87, t.100s, t.111s,
 t.120, t.126s
 Supervisor: t.39, t.94, t.99

 Take hold of electrical equipment with
 non-sword arm: t.22, t.120
 Taking off mask before 'Halt!': t.87,
 t.120
 Target: see «Valid target»
 TAS (Sports Arbitration Tribunal):
 t.94, t.99
 Team (captain): t.33s, t.82, t.90
 Team (replacement of a fencer): t.33
 Tearing out of spool: t.21
 Technician: t.92, t.108
 Television: t.42
 Temporary suspension: t.100s, t.111,
 t.120
 Terminology: t.2ss
 Testing (anti-doping): t.129
 Tests (equipment): t.35, t.54, t.68,
 t.73
 Third place (deciding, in case of
 disqualification): t.105
 Threaten valid target: t.7, t.10, t.56,
 t.75, t.77
 Throwing (weapon): t.16
 Thrusting (weapons of): t.46, t.61, t.70
 Time (fencing): t.6, t.8, t.59, t.60, t.77,
 t.80
 Time (remaining/expiry): t.31s
 Time-keeper: t.30, t.32, t.35
 Tournament: t.107s: see «World
 Cup», «Competitions»
 Trainer: t.81, t.92, t.96, t.108
 Travel (of the point): t.34, t.44s
 Tribunal: t.94
 Turn back on opponent: t.21, t.120

 Under-plastron: t.43, t.45
 Undressing (forbidden on the piste):
 t.86
 Unplugging of bodywire: t.68
 Unwillingness to fight (passivity):
 t.87
 Use of non-sword hand/arm: t.22s,
 t.36, t.120
 Utmost ability (fence to): t.88, t.120

 Valid target (covering and
 substitution): t.22s, t.36, t.49,
 t.72, t.120
 Valid target (definition): t.47ss, t.62,
 t.71s
 Valid target (threaten): t.7, t.10, t.56,
 t.75, t.77
 Validity of hit: t.42, t.51ss, t.65ss,
 t.74ss
 Vest: see «Jacket (conductive)»,
 «Jacket (fencing)»
 Violence: t.87, t.103, t.105, t.120
 Violent fencing: t.87
 Visual signals: see «Lamps»

 WADA: t.127
 Warning (penalty): t.114, t.116, t.118,
 t.120
 Weapon (throwing): t.16
 Weapon (working order/spare): t.45,
 t.86, t.120
 Width of piste: see «Piste»
 Withdrawal: t.33
 World Championships: t.45
 World Cup: t.35, t.45
 World Cup (Directoire Technique):
 t.39
 World Cup (Supervisor): t.39

 Yellow Card: t.86, t.114, t.116, t.118,
 t.120

